

| | | |
|---------|---------------|-----------|
| UNIT | COOLING TOWER | |
| MODEL # | AT 17-4118 | SCALE NTS |

EVAPCO, INC.

| | | | |
|----------|-------------------|------|-----------|
| DWG. # | CT4C071848-DRA-ST | REV. | - |
| SERIAL # | | DATE | 6/30/2026 |

- NOTES:**
- (M)- FAN MOTOR LOCATION
 - HEAVIEST SECTION IS FAN/CASING SECTION
 - MPT DENOTES MALE PIPE THREAD
FPT DENOTES FEMALE PIPE THREAD
BFW DENOTES BEVELED FOR WELDING
GVD DENOTES GROOVED
FLG DENOTES FLANGE
 - +UNIT WEIGHT DOES NOT INCLUDE ACCESSORIES (SEE ACCESSORY DRAWINGS)
 - 3/4" [19MM] DIA. MOUNTING HOLES. REFER TO RECOMMENDED STEEL SUPPORT DRAWING
 - DIMENSIONS LISTED AS FOLLOWS:
ENGLISH FT-IN
[METRIC] [mm]
 - MAKE-UP WATER PRESSURE
20 psi MIN [137 kPa], 50 psi MAX [344 kPa]

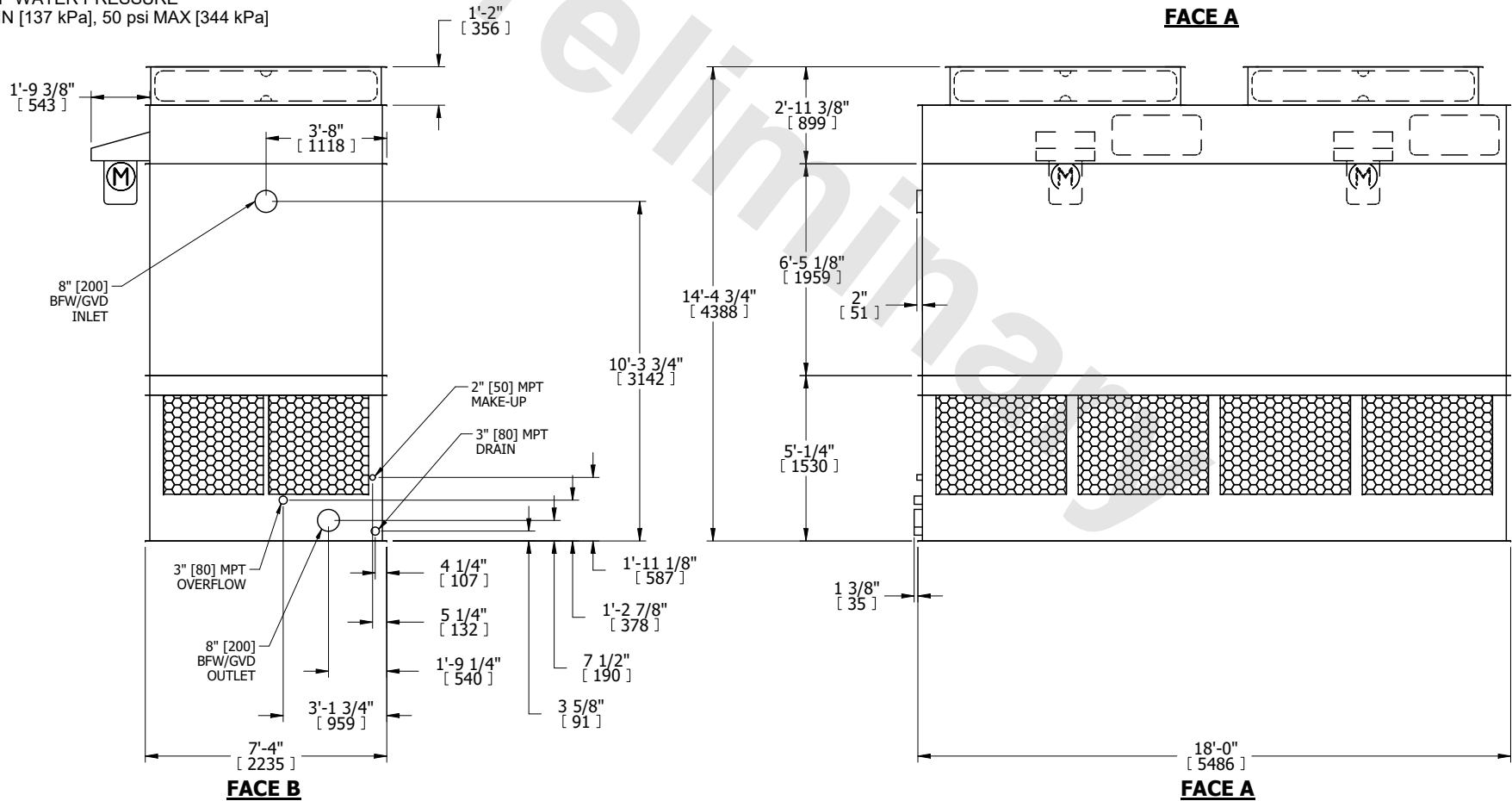
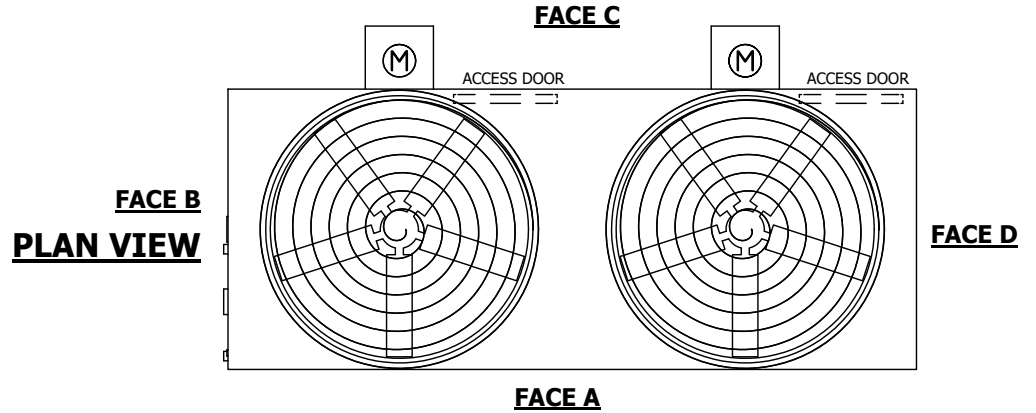

| | | | | | | | | | |
|-----------------|----------------------|------------------|-----------------------|-------------------------|----------------------|--------------------------|---|-----------|-----|
| SHIPPING WEIGHT | 8520 lbs+ [3865] kg+ | OPERATING WEIGHT | 13650 lbs+ [6195] kg+ | HEAVIEST SECTION WEIGHT | 5890 lbs+ [2675] kg+ | NO. OF SHIPPING SECTIONS | 2 | DRAWN BY: | MBG |
|-----------------|----------------------|------------------|-----------------------|-------------------------|----------------------|--------------------------|---|-----------|-----|