

EVAPCO, INC.



UNIT CLOSED CIRCUIT COOLER	MODEL # ATWB 24-4O18	SCALE	DWG. # WB3241808-DRA-ST	REV.	DATE 6/27/2026	SERIAL #
--------------------------------------	--------------------------------	-------	-----------------------------------	------	--------------------------	----------

- NOTES:
- (M)- FAN MOTOR LOCATION
 - HEAVIEST SECTION IS UPPER SECTION
 - MPT DENOTES MALE PIPE THREAD
FPT DENOTES FEMALE PIPE THREAD
BFW DENOTES BEVELED FOR WELDING
 - +UNIT WEIGHT DOES NOT INCLUDE ACCESSORIES (SEE ACCESSORY DRAWINGS)
 - MAKE-UP WATER PRESSURE
20 psi MIN [137 kPa], 50 psi MAX [344 kPa]
 - *-APPROXIMATE DIMENSIONS DO NOT USE FOR PRE-FABRICATION OF CONNECTING PIPING

**FACE 2
PLAN VIEW**

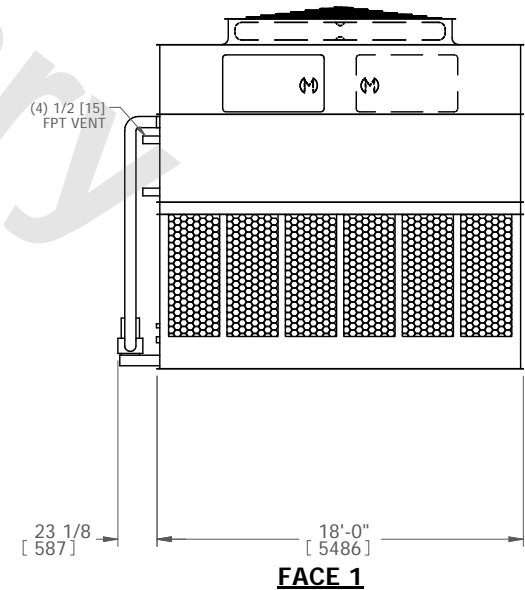
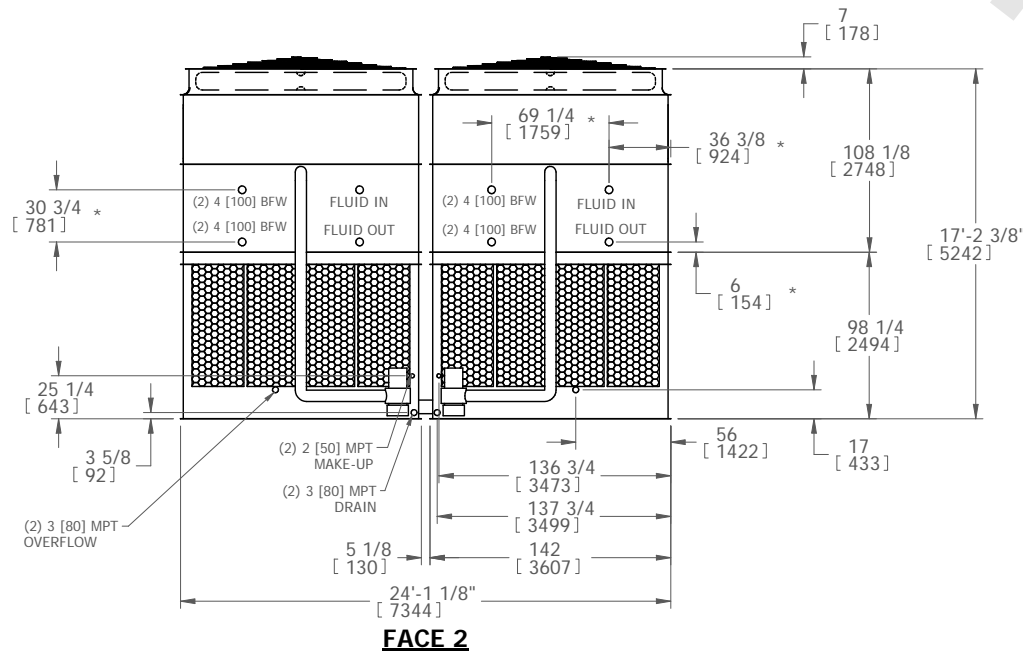
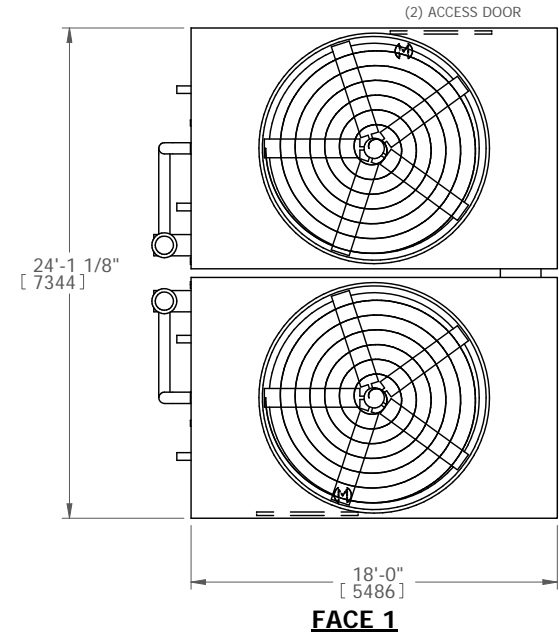

SHIPPING WEIGHT 47880 lbs+ [21718] kg+	OPERATING WEIGHT 76220 lbs+ [34573] kg+	HEAVIEST SECTION WEIGHT 20020 lbs+ [9081] kg+	NO. OF SHIPPING SECTIONS 4
--	---	---	--------------------------------------