

|         |                       |           |
|---------|-----------------------|-----------|
| UNIT    | CLOSED CIRCUIT COOLER |           |
| MODEL # | ATWB 24-7M36          | SCALE NTS |

# EVAPCO, INC.

|          |                  |      |           |
|----------|------------------|------|-----------|
| DWG. #   | WB3243614-DRC-ST | REV. | -         |
| SERIAL # |                  | DATE | 6/25/2026 |

- NOTES:
- (M)- FAN MOTOR LOCATION
  - HEAVIEST SECTION IS UPPER SECTION
  - MPT DENOTES MALE PIPE THREAD  
FPT DENOTES FEMALE PIPE THREAD  
BFW DENOTES BEVELED FOR WELDING  
GVD DENOTES GROOVED  
FLG DENOTES FLANGE  
PE DENOTES PLAIN END
  - +UNIT WEIGHT DOES NOT INCLUDE ACCESSORIES (SEE ACCESSORY DRAWINGS)
  - MAKE-UP WATER PRESSURE  
20 psi MIN [137 kPa], 50 psi MAX [344 kPa]
  - \*-APPROXIMATE DIMENSIONS DO NOT USE FOR PRE-FABRICATION OF CONNECTING PIPING
  - 3/4" [19mm] DIA. MOUNTING HOLES. REFER TO RECOMMENDED STEEL SUPPORT DRAWING.
  - DIMENSIONS LISTED AS FOLLOWS:  
ENGLISH FT-IN  
METRIC [mm]

**FACE B**  
**PLAN VIEW**

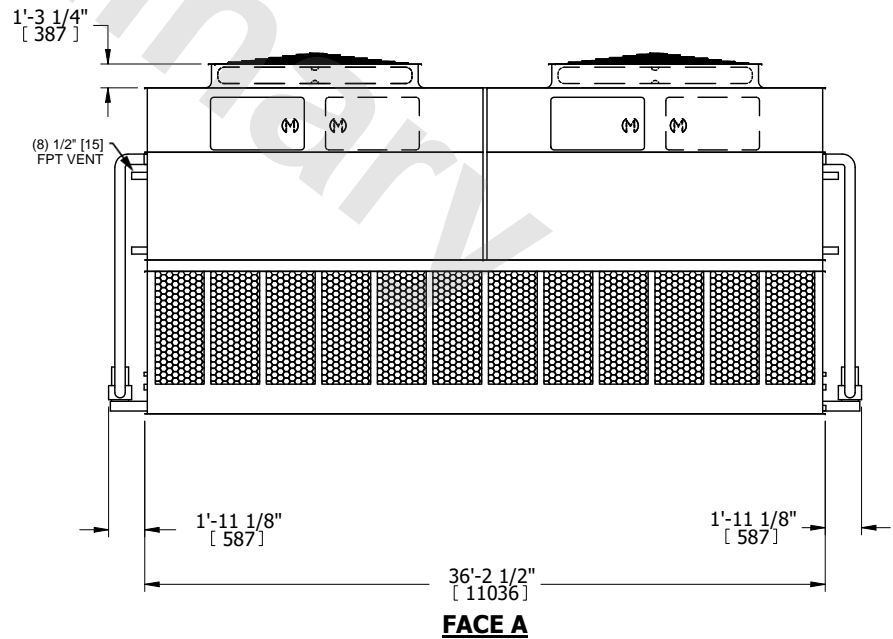
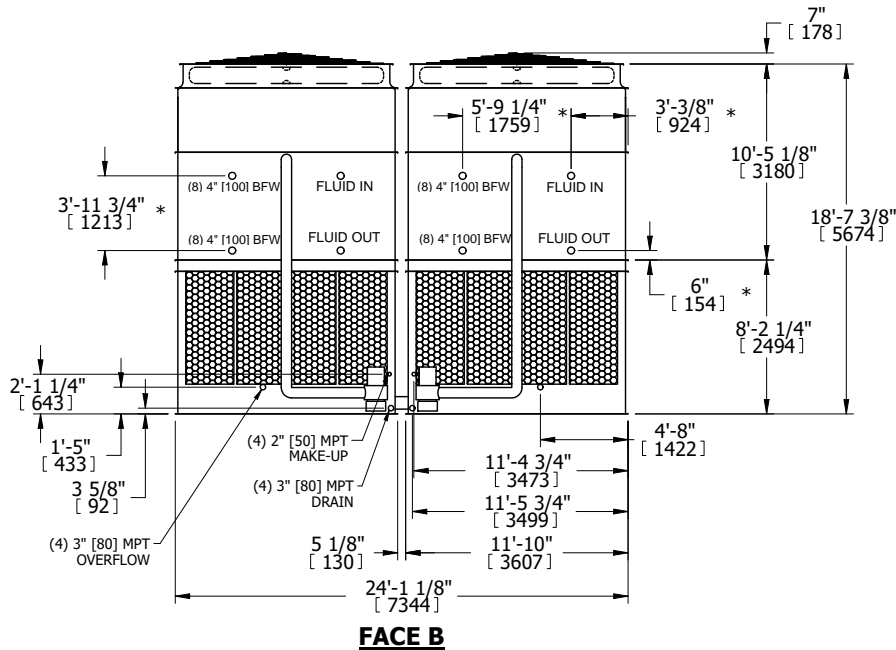
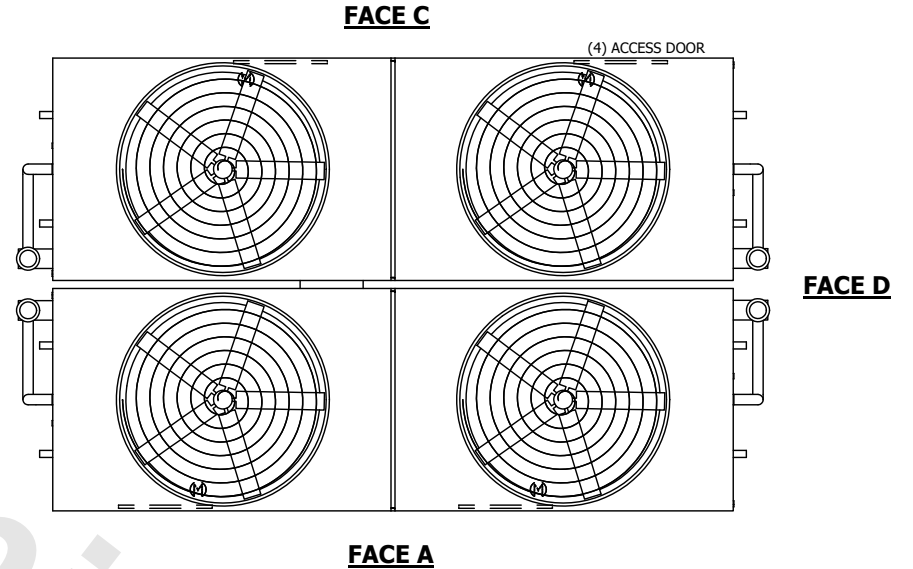

|                 |                         |                  |                         |                         |                        |                          |   |           |     |
|-----------------|-------------------------|------------------|-------------------------|-------------------------|------------------------|--------------------------|---|-----------|-----|
| SHIPPING WEIGHT | 138120 lbs+ [62655] kg+ | OPERATING WEIGHT | 209720 lbs+ [95130] kg+ | HEAVIEST SECTION WEIGHT | 30460 lbs+ [13820] kg+ | NO. OF SHIPPING SECTIONS | 6 | DRAWN BY: | SLR |
|-----------------|-------------------------|------------------|-------------------------|-------------------------|------------------------|--------------------------|---|-----------|-----|