

UNIT	CLOSED CIRCUIT COOLER	
MODEL #	ATWB 17-3L12-Z	SCALE NTS



DWG. #	WB3171206-DRD-SF	REV.	-
SERIAL #		DATE	6/27/2026

- NOTES:
- (M)- FAN MOTOR LOCATION
  - HEAVIEST SECTION IS UPPER SECTION
  - MPT DENOTES MALE PIPE THREAD  
FPT DENOTES FEMALE PIPE THREAD  
BFW DENOTES BEVELED FOR WELDING  
GVD DENOTES GROOVED  
FLG DENOTES FLANGE  
PE DENOTES PLAIN END
  - +UNIT WEIGHT DOES NOT INCLUDE ACCESSORIES (SEE ACCESSORY DRAWINGS)
  - MAKE-UP WATER PRESSURE  
20 psi MIN [137 kPa], 50 psi MAX [344 kPa]
  - \*-APPROXIMATE DIMENSIONS DO NOT USE FOR PRE-FABRICATION OF CONNECTING PIPING
  - SERIES FLOW PIPING AND AUX. CROSSOVER DRAIN BY OTHERS.
  - 3/4" [19mm] DIA. MOUNTING HOLES. REFER TO RECOMMENDED STEEL SUPPORT DRAWING.
  - DIMENSIONS LISTED AS FOLLOWS:  
ENGLISH FT-IN  
METRIC [mm]

Preliminary

**FACE B**  
**PLAN VIEW**

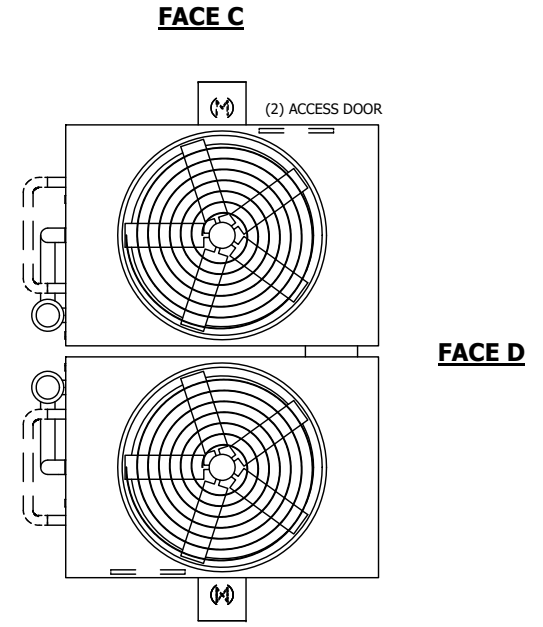

**FACE A**



SHIPPING WEIGHT	20320 lbs+ [9220] kg+	OPERATING WEIGHT	31200 lbs+ [14155] kg+	HEAVIEST SECTION WEIGHT	8360 lbs+ [3795] kg+	NO. OF SHIPPING SECTIONS	4	DRAWN BY:	JLG
-----------------	-----------------------	------------------	------------------------	-------------------------	----------------------	--------------------------	---	-----------	-----