

EVAPCO, INC.



UNIT CLOSED CIRCUIT COOLER	MODEL # ATWB 24-3M18-Z	SCALE	DWG. # WB3241806-DRA-SF	REV.	DATE 4/29/2026	SERIAL #
--------------------------------------	----------------------------------	-------	-----------------------------------	------	--------------------------	----------

- NOTES:
- (M)- FAN MOTOR LOCATION
 - HEAVIEST SECTION IS UPPER SECTION
 - MPT DENOTES MALE PIPE THREAD
FPT DENOTES FEMALE PIPE THREAD
BFW DENOTES BEVELED FOR WELDING
 - +UNIT WEIGHT DOES NOT INCLUDE ACCESSORIES (SEE ACCESSORY DRAWINGS)
 - MAKE-UP WATER PRESSURE
20 psi MIN [137 kPa], 50 psi MAX [344 kPa]
 - * -APPROXIMATE DIMENSIONS DO NOT USE FOR PRE-FABRICATION OF CONNECTING PIPING
 - SERIES FLOW PIPING AND AUX. CROSSOVER DRAIN BY OTHERS.

FACE 2 PLAN VIEW

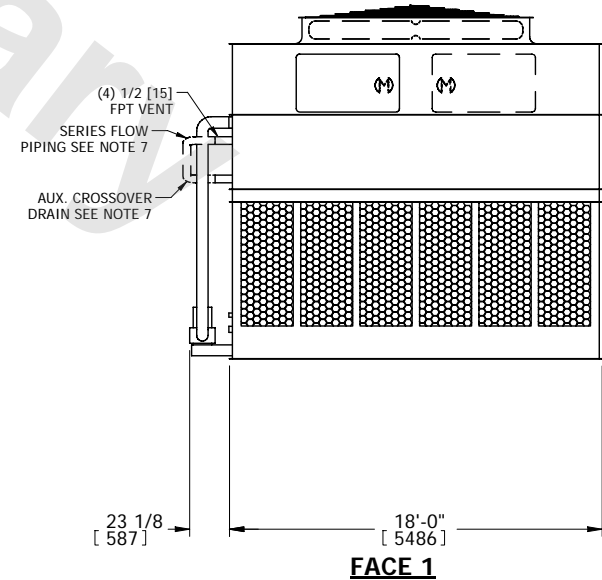
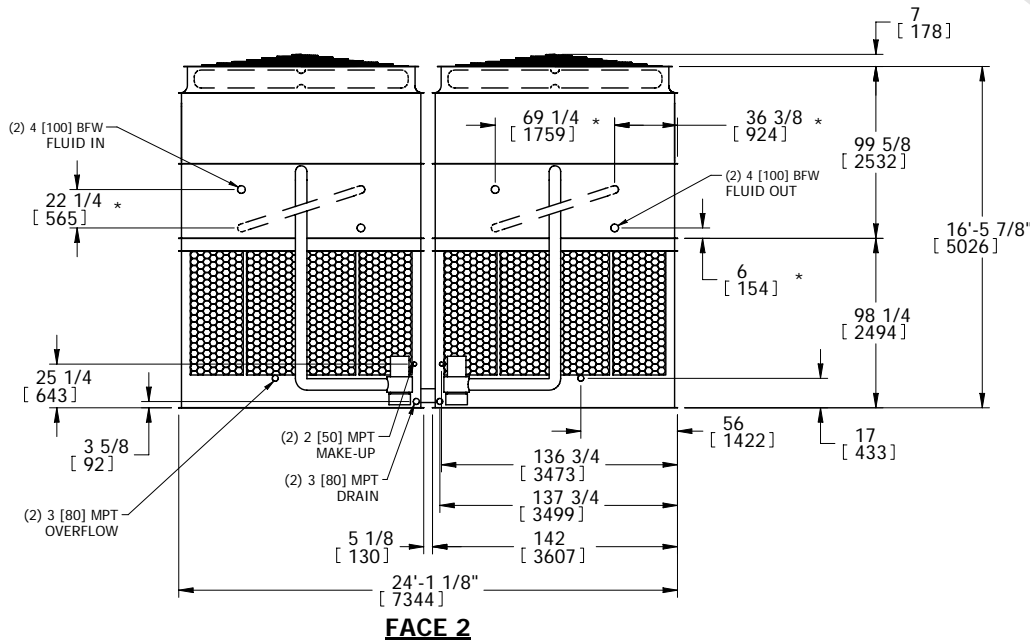
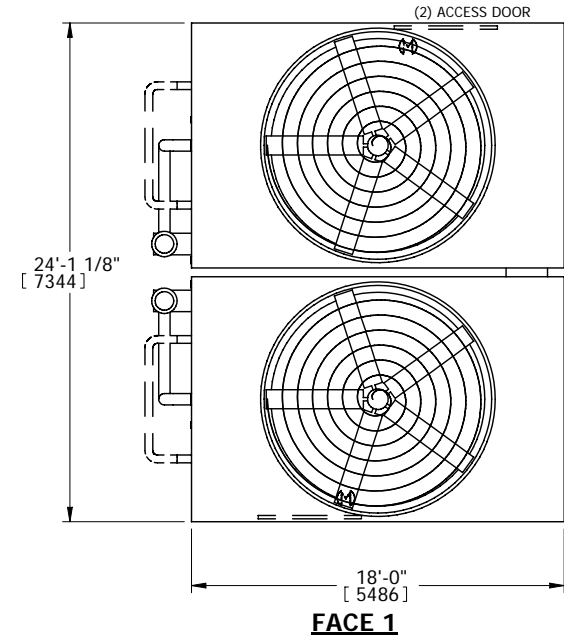

SHIPPING WEIGHT 41000 lbs+ [18597] kg+	OPERATING WEIGHT 66880 lbs+ [30336] kg+	HEAVIEST SECTION WEIGHT 16580 lbs+ [7521] kg+	NO. OF SHIPPING SECTIONS 4
--	---	---	--------------------------------------