

| | | |
|---------|-----------------------|-----------|
| UNIT | CLOSED CIRCUIT COOLER | |
| MODEL # | ATWB 7-6J18-Z | SCALE NTS |

EVAPCO, INC.

| | | | |
|----------|-------------------|------|-----------|
| DWG. # | CW4C071812-DRA-SF | REV. | - |
| SERIAL # | | DATE | 6/20/2026 |

- NOTES:
- (M)- FAN MOTOR LOCATION
 - HEAVIEST SECTION IS FAN/CASING SECTION
 - MPT DENOTES MALE PIPE THREAD
FPT DENOTES FEMALE PIPE THREAD
BFW DENOTES BEVELED FOR WELDING
GVD DENOTES GROOVED
FLG DENOTES FLANGE
PE DENOTES PLAIN END
 - +UNIT WEIGHT DOES NOT INCLUDE ACCESSORIES (SEE ACCESSORY DRAWINGS)
 - MAKE-UP WATER PRESSURE
20 psi MIN [137 kPa], 50 psi MAX [344 kPa]
 - *-APPROXIMATE DIMENSIONS DO NOT USE FOR PRE-FABRICATION OF CONNECTING PIPING
 - SERIES FLOW PIPING AND AUX. CROSSOVER DRAIN BY OTHERS.
 - 3/4" [19MM] DIA. MOUNTING HOLES. REFER TO RECOMMENDED STEEL SUPPORT DRAWING.
 - DIMENSIONS LISTED AS FOLLOWS:
ENGLISH FT-IN
METRIC [mm]

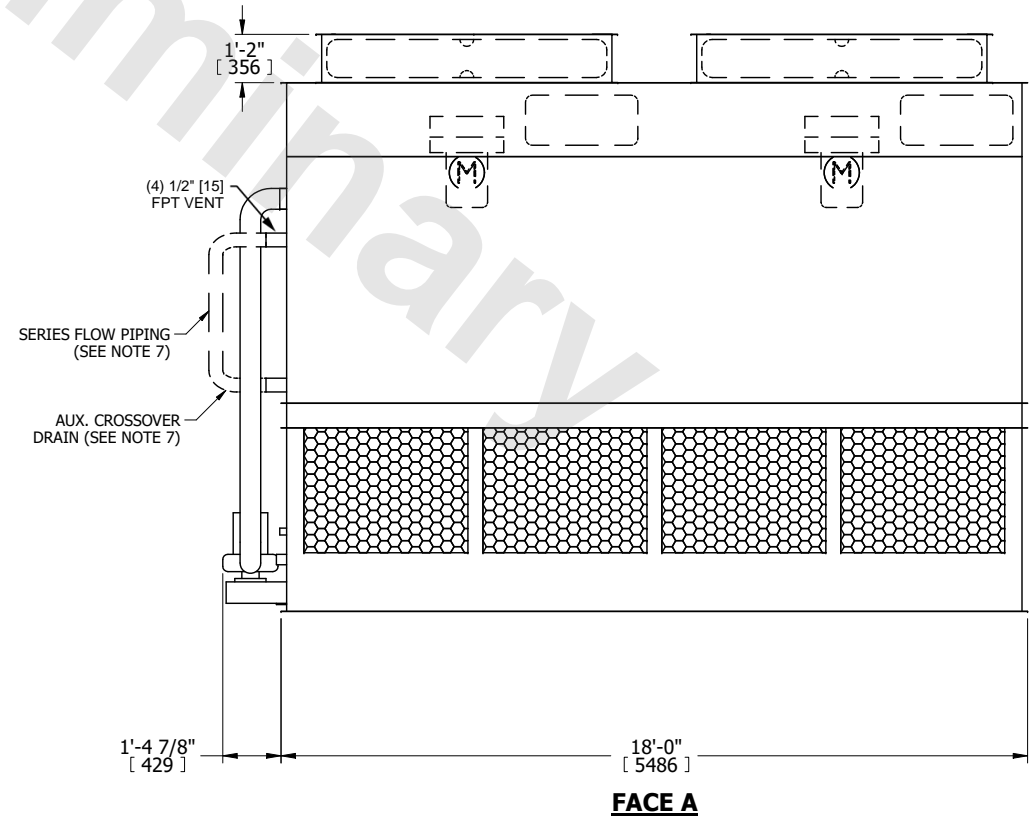
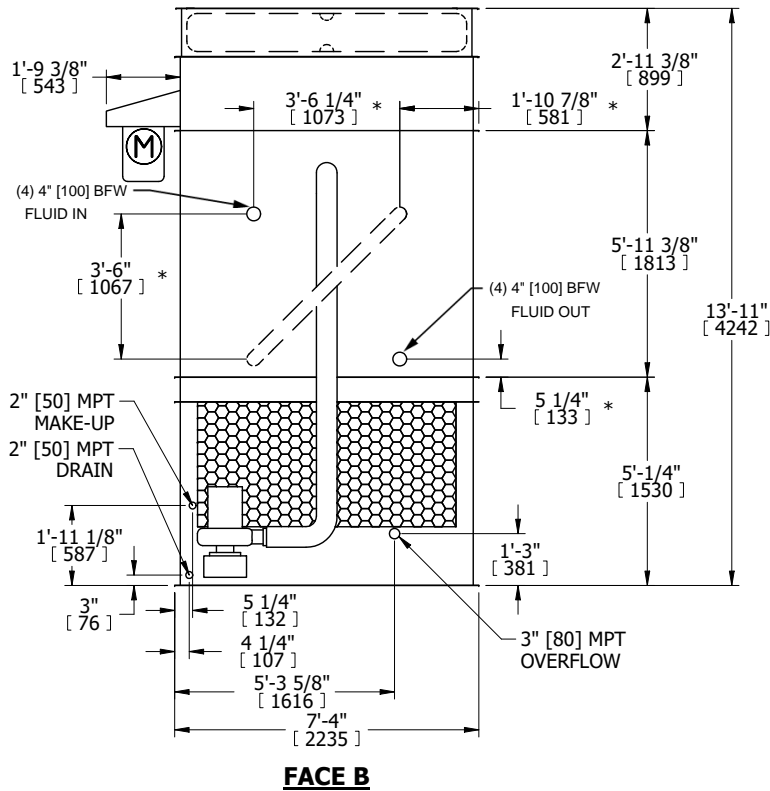
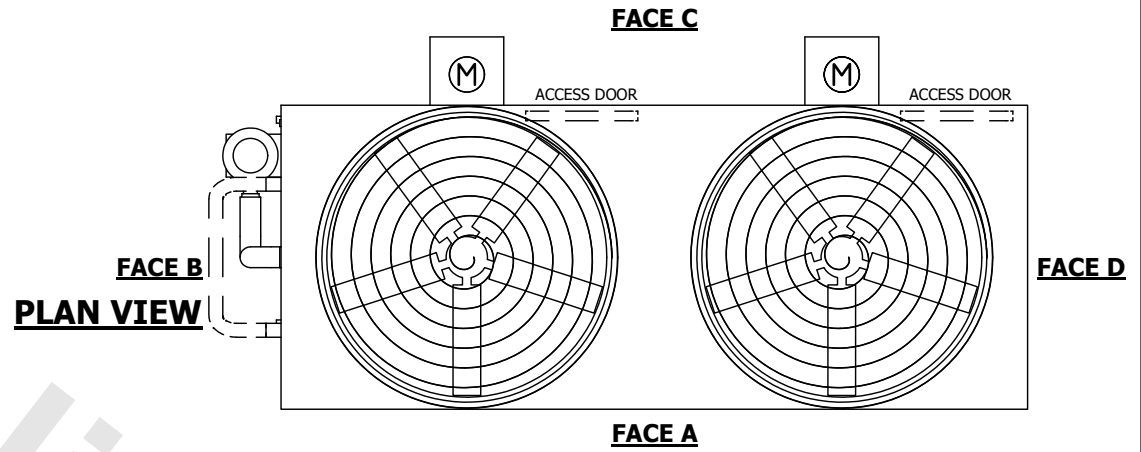

| | | | | | | | | | |
|-----------------|-----------------------|------------------|------------------------|-------------------------|-----------------------|--------------------------|---|-----------|-----|
| SHIPPING WEIGHT | 20630 lbs+ [9360] kg+ | OPERATING WEIGHT | 28150 lbs+ [12770] kg+ | HEAVIEST SECTION WEIGHT | 17610 lbs+ [7990] kg+ | NO. OF SHIPPING SECTIONS | 2 | DRAWN BY: | TAM |
|-----------------|-----------------------|------------------|------------------------|-------------------------|-----------------------|--------------------------|---|-----------|-----|