

| | | |
|---------|-----------------------|-----------|
| UNIT | CLOSED CIRCUIT COOLER | |
| MODEL # | LRWB 8-4L9 | SCALE NTS |



| | | | |
|----------|-----------------|------|-----------|
| DWG. # | WV080908-DRD-ST | REV. | - |
| SERIAL # | | DATE | 5/10/2026 |

- NOTES:
- (M)- FAN MOTOR LOCATION
 - MPT DENOTES MALE PIPE THREAD
FPT DENOTES FEMALE PIPE THREAD
BFW DENOTES BEVELED FOR WELDING
GVD DENOTES GROOVED
FLG DENOTES FLANGE
PE DENOTES PLAIN END
 - +UNIT WEIGHT DOES NOT INCLUDE ACCESSORIES (SEE ACCESSORY DRAWINGS)
 - 3/4" [19mm] DIA. MOUNTING HOLES. REFER TO RECOMMENDED STEEL SUPPORT DRAWING
 - DIMENSIONS LISTED AS FOLLOWS: ENGLISH FT IN [METRIC] [mm]
 - * - APPROXIMATE DIMENSIONS DO NOT USE FOR PRE-FABRICATION OF CONNECTING PIPING
 - MAKE-UP WATER PRESSURE
20 psi [137 kPa] MIN, 50 psi [344 kPa] MAX

FACE B
PLAN VIEW

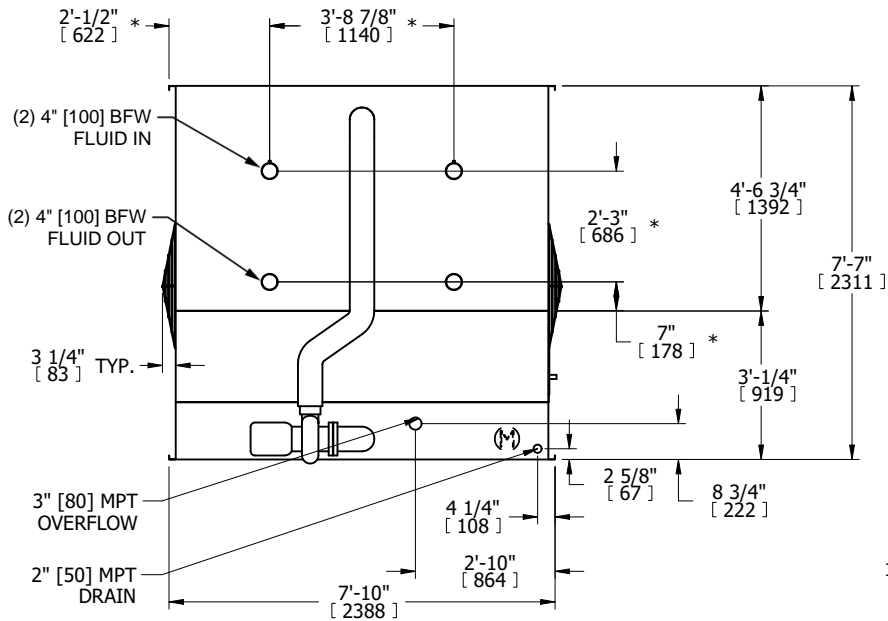
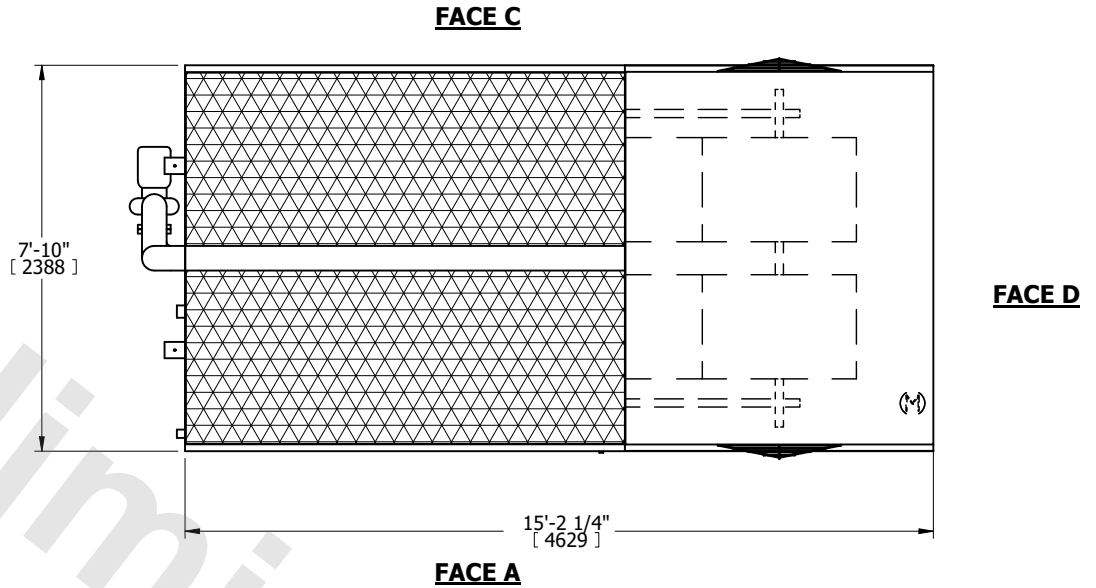

FACE B



FACE A

| | | | | | | | | | |
|-----------------|----------------------|------------------|-----------------------|-------------------------|----------------------|--------------------------|---|-----------|-----|
| SHIPPING WEIGHT | 8600 lbs+ [3905] kg+ | OPERATING WEIGHT | 13650 lbs+ [6195] kg+ | HEAVIEST SECTION WEIGHT | 8600 lbs+ [3905] kg+ | NO. OF SHIPPING SECTIONS | 1 | DRAWN BY: | TLS |
|-----------------|----------------------|------------------|-----------------------|-------------------------|----------------------|--------------------------|---|-----------|-----|