

UNIT	CLOSED CIRCUIT COOLER	
MODEL #	LRWB 8-6N12	SCALE NTS



DWG. #	WV081212-DRD-ST	REV.	-
SERIAL #		DATE	6/23/2026

- NOTES:
- (M)- FAN MOTOR LOCATION
  - MPT DENOTES MALE PIPE THREAD  
FPT DENOTES FEMALE PIPE THREAD  
BFW DENOTES BEVELED FOR WELDING  
GVD DENOTES GROOVED  
FLG DENOTES FLANGE  
PE DENOTES PLAIN END
  - +UNIT WEIGHT DOES NOT INCLUDE ACCESSORIES (SEE ACCESSORY DRAWINGS)
  - 3/4" [19mm] DIA. MOUNTING HOLES. REFER TO RECOMMENDED STEEL SUPPORT DRAWING
  - DIMENSIONS LISTED AS FOLLOWS: ENGLISH FT IN [METRIC] [mm]
  - \* - APPROXIMATE DIMENSIONS DO NOT USE FOR PRE-FABRICATION OF CONNECTING PIPING
  - MAKE-UP WATER PRESSURE  
20 psi [137 kPa] MIN, 50 psi [344 kPa] MAX

**FACE B**  
**PLAN VIEW**

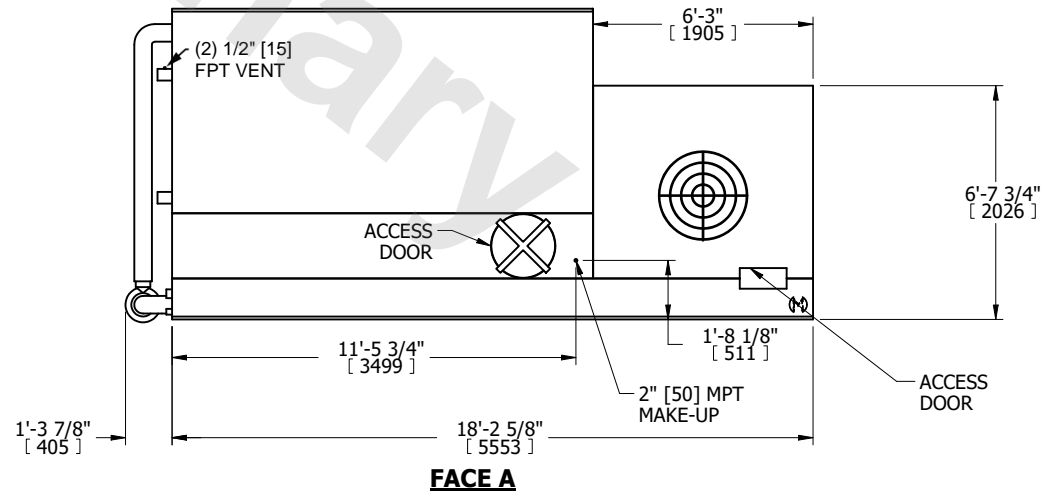
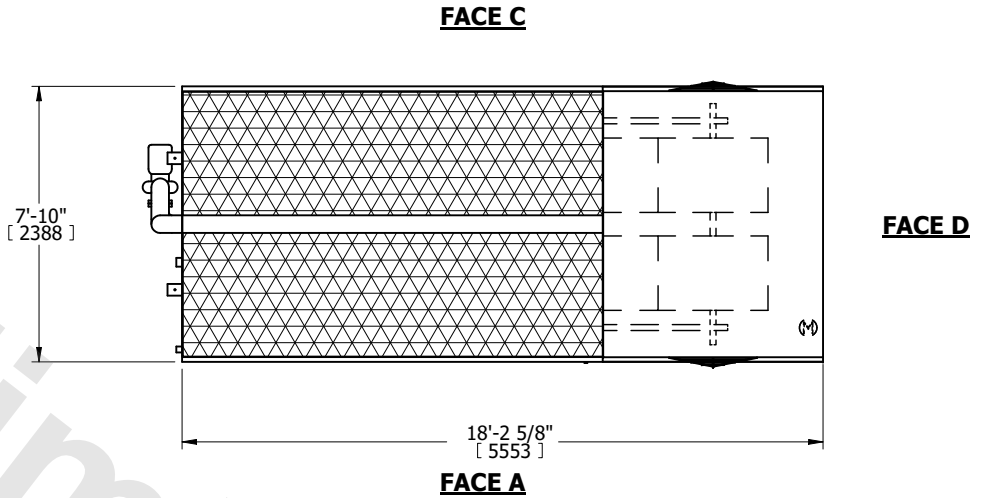

SHIPPING WEIGHT	13340 lbs+ [6055] kg+	OPERATING WEIGHT	21250 lbs+ [9640] kg+	HEAVIEST SECTION WEIGHT	13340 lbs+ [6055] kg+	NO. OF SHIPPING SECTIONS	1	DRAWN BY:	TLS
-----------------	-----------------------	------------------	-----------------------	-------------------------	-----------------------	--------------------------	---	-----------	-----