

|         |                       |           |
|---------|-----------------------|-----------|
| UNIT    | CLOSED CIRCUIT COOLER |           |
| MODEL # | LRWB 8-6012           | SCALE NTS |



|          |                 |      |            |
|----------|-----------------|------|------------|
| DWG. #   | WV081212-DRD-ST | REV. | -          |
| SERIAL # |                 | DATE | 10/31/2024 |

- NOTES:
- (M)- FAN MOTOR LOCATION
  - MPT DENOTES MALE PIPE THREAD  
FPT DENOTES FEMALE PIPE THREAD  
BFW DENOTES BEVELED FOR WELDING  
GVD DENOTES GROOVED  
FLG DENOTES FLANGE  
PE DENOTES PLAIN END
  - +UNIT WEIGHT DOES NOT INCLUDE ACCESSORIES (SEE ACCESSORY DRAWINGS)
  - 3/4" [19mm] DIA. MOUNTING HOLES. REFER TO RECOMMENDED STEEL SUPPORT DRAWING
  - DIMENSIONS LISTED AS FOLLOWS: ENGLISH FT IN [METRIC] [mm]
  - \* - APPROXIMATE DIMENSIONS DO NOT USE FOR PRE-FABRICATION OF CONNECTING PIPING
  - MAKE-UP WATER PRESSURE  
20 psi [137 kPa] MIN, 50 psi [344 kPa] MAX

**FACE B**  
**PLAN VIEW**

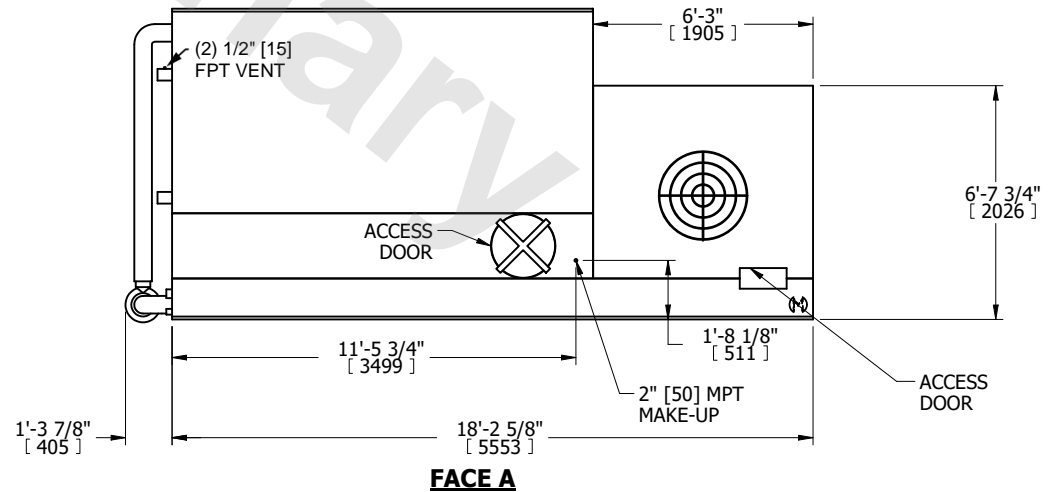
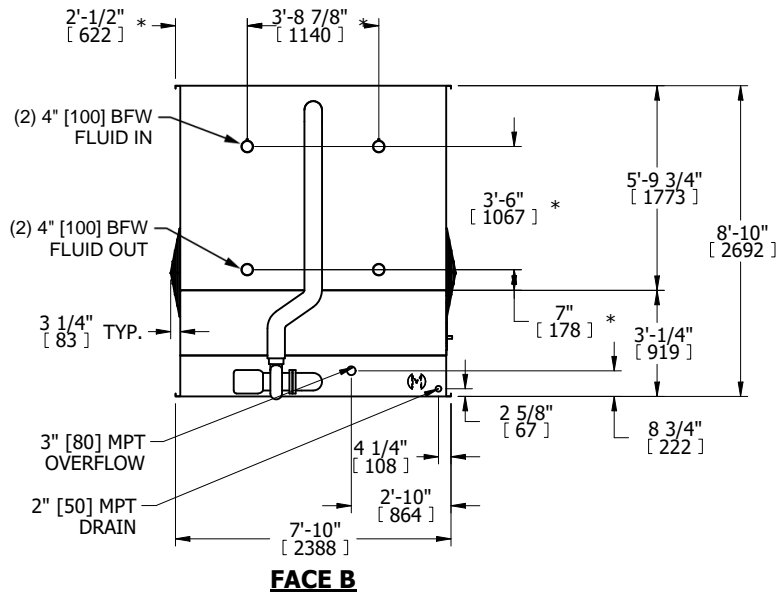
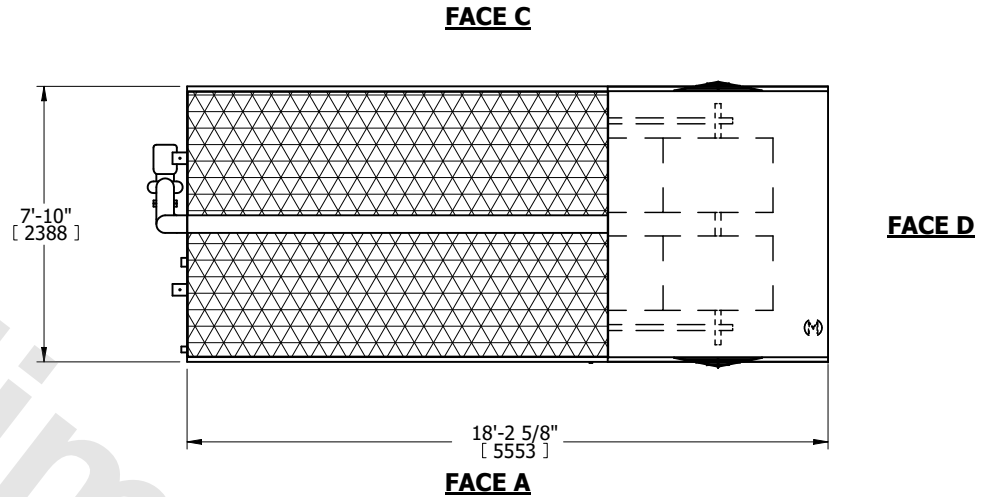

|                 |                       |                  |                       |                         |                       |                          |   |           |     |
|-----------------|-----------------------|------------------|-----------------------|-------------------------|-----------------------|--------------------------|---|-----------|-----|
| SHIPPING WEIGHT | 13350 lbs+ [6060] kg+ | OPERATING WEIGHT | 21260 lbs+ [9645] kg+ | HEAVIEST SECTION WEIGHT | 13350 lbs+ [6060] kg+ | NO. OF SHIPPING SECTIONS | 1 | DRAWN BY: | TLS |
|-----------------|-----------------------|------------------|-----------------------|-------------------------|-----------------------|--------------------------|---|-----------|-----|