

UNIT	CLOSED CIRCUIT COOLER	
MODEL #	LSWE 4-3F6-Z	SCALE NTS



DWG. #	WLE040606-DRD-SF	REV.	-
SERIAL #		DATE	7/6/2026

- NOTES:
- (M)- FAN MOTOR LOCATION
  - MPT DENOTES MALE PIPE THREAD  
FPT DENOTES FEMALE PIPE THREAD  
BFW DENOTES BEVELED FOR WELDING  
GVD DENOTES GROOVED  
FLG DENOTES FLANGE  
PE DENOTES PLAIN END
  - +UNIT WEIGHT DOES NOT INCLUDE ACCESSORIES (SEE ACCESSORY DRAWINGS)
  - 3/4" [19mm] DIA. MOUNTING HOLES. REFER TO RECOMMENDED STEEL SUPPORT DRAWING
  - DIMENSIONS LISTED AS FOLLOWS: ENGLISH FT IN [METRIC] [mm]
  - \* - APPROXIMATE DIMENSIONS DO NOT USE FOR PRE-FABRICATION OF CONNECTING PIPING
  - HEAVIEST SECTION IS COIL SECTION
  - MAKE-UP WATER PRESSURE  
20 psi [137 kPa] MIN, 50 psi [344 kPa] MAX
  - MAKE-UP CONNECTION LOCATED 7-5/8" [194] FROM CONNECTION END OF UNIT
  - SERIES FLOW PIPING AND AUX. CROSSOVER DRAIN ARE BY OTHERS

**FACE B**  
**PLAN VIEW**



**FACE C**

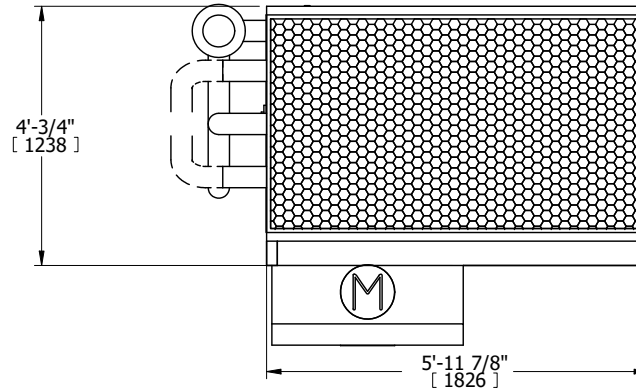

**FACE D**

**FACE A**

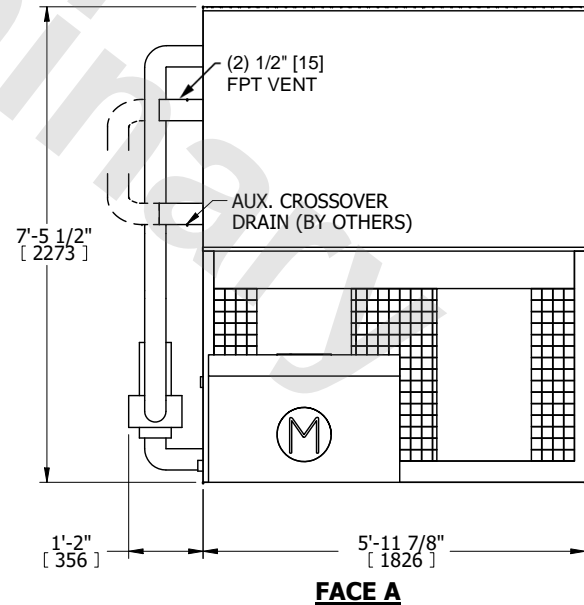

SHIPPING WEIGHT	2720 lbs+ [1235] kg+	OPERATING WEIGHT	3770 lbs+ [1715] kg+	HEAVIEST SECTION WEIGHT	1590 lbs+ [725] kg+	NO. OF SHIPPING SECTIONS	2	DRAWN BY:	TLS
-----------------	----------------------	------------------	----------------------	-------------------------	---------------------	--------------------------	---	-----------	-----