

UNIT	CLOSED CIRCUIT COOLER	
MODEL #	LSWE 10-5024-Z	SCALE NTS

# EVAPCO, INC.

DWG. #	WLETM2410-DRD-SF	REV.	-
SERIAL #		DATE	7/5/2026

- NOTES:
- (M)- FAN MOTOR LOCATION
  - MPT DENOTES MALE PIPE THREAD  
FPT DENOTES FEMALE PIPE THREAD  
BFW DENOTES BEVELED FOR WELDING  
GVD DENOTES GROOVED  
FLG DENOTES FLANGE  
PE DENOTES PLAIN END
  - +UNIT WEIGHT DOES NOT INCLUDE ACCESSORIES (SEE ACCESSORY DRAWINGS)
  - 3/4" [19mm] DIA. MOUNTING HOLES. REFER TO RECOMMENDED STEEL SUPPORT DRAWING
  - DIMENSIONS LISTED AS FOLLOWS: ENGLISH FT IN [METRIC] [mm]
  - \* - APPROXIMATE DIMENSIONS DO NOT USE FOR PRE-FABRICATION OF CONNECTING PIPING
  - HEAVIEST SECTION IS COIL SECTION
  - MAKE-UP WATER PRESSURE  
20 psi [137 kPa] MIN, 50 psi [344 kPa] MAX
  - SERIES FLOW PIPING AND AUX. CROSSOVER DRAIN ARE BY OTHERS

**FACE B**  
**PLAN VIEW**

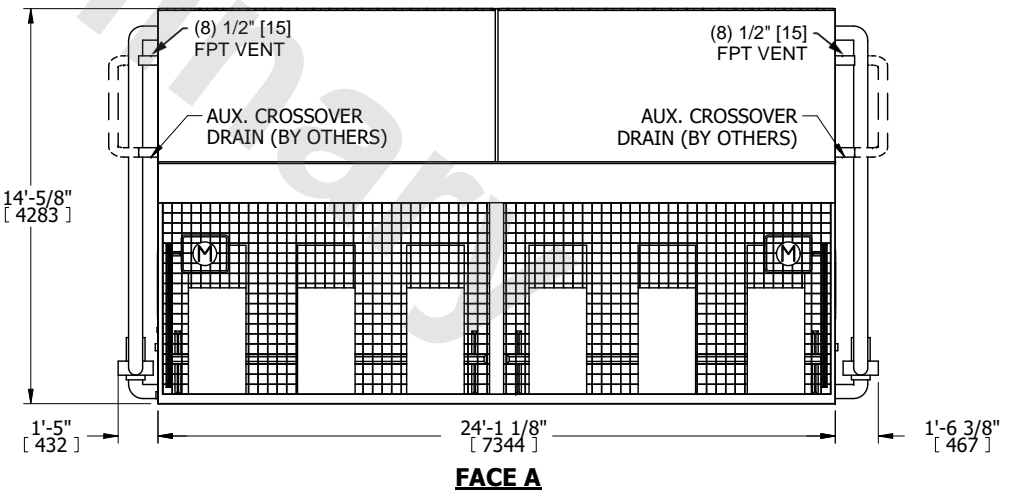
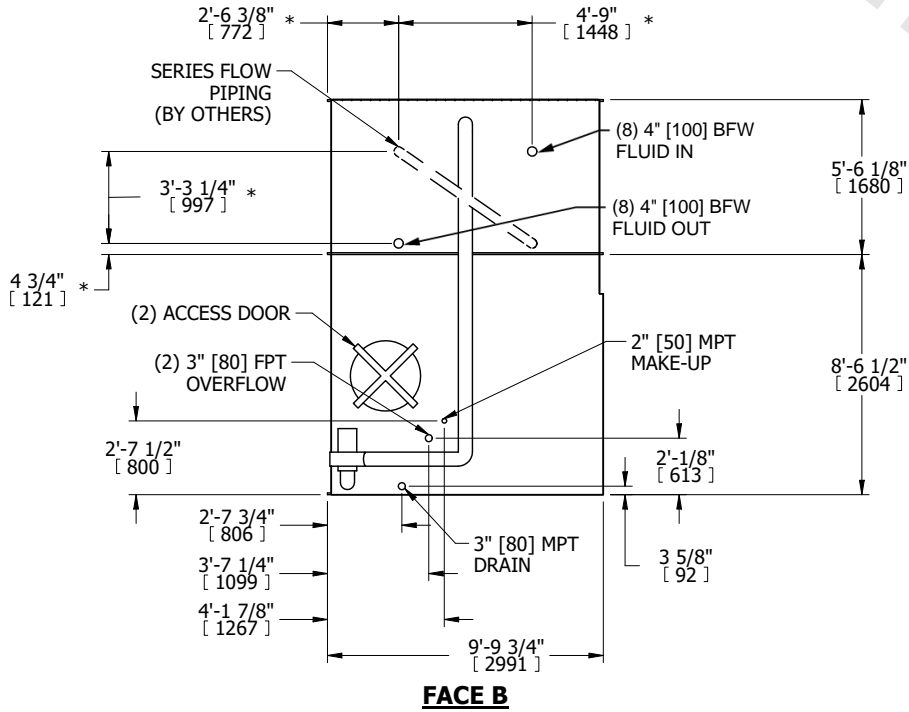
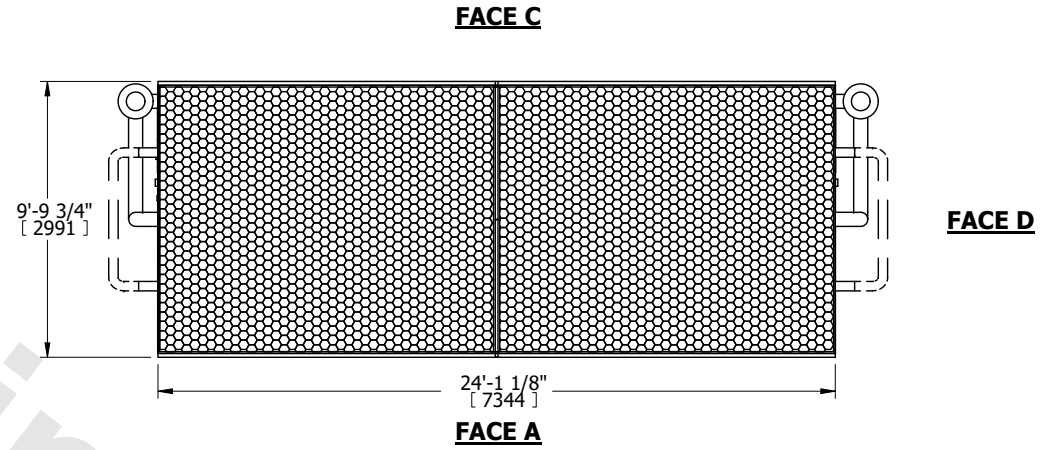

SHIPPING WEIGHT	33980 lbs+ [15415] kg+	OPERATING WEIGHT	49720 lbs+ [22555] kg+	HEAVIEST SECTION WEIGHT	11610 lbs+ [5270] kg+	NO. OF SHIPPING SECTIONS	3	DRAWN BY:	TLS
-----------------	------------------------	------------------	------------------------	-------------------------	-----------------------	--------------------------	---	-----------	-----