

UNIT	CLOSED CIRCUIT COOLER	
MODEL #	eco-LRWB 8-5L9	SCALE NTS



DWG. #	WV080910-DRD-ST	REV.	-
SERIAL #		DATE	5/7/2026

- NOTES:
- (M)- FAN MOTOR LOCATION
 - MPT DENOTES MALE PIPE THREAD
FPT DENOTES FEMALE PIPE THREAD
BFW DENOTES BEVELED FOR WELDING
GVD DENOTES GROOVED
FLG DENOTES FLANGE
PE DENOTES PLAIN END
 - +UNIT WEIGHT DOES NOT INCLUDE ACCESSORIES (SEE ACCESSORY DRAWINGS)
 - 3/4" [19mm] DIA. MOUNTING HOLES. REFER TO RECOMMENDED STEEL SUPPORT DRAWING
 - DIMENSIONS LISTED AS FOLLOWS: ENGLISH FT IN [METRIC] [mm]
 - * - APPROXIMATE DIMENSIONS DO NOT USE FOR PRE-FABRICATION OF CONNECTING PIPING
 - MAKE-UP WATER PRESSURE
20 psi [137 kPa] MIN, 50 psi [344 kPa] MAX

FACE B
PLAN VIEW

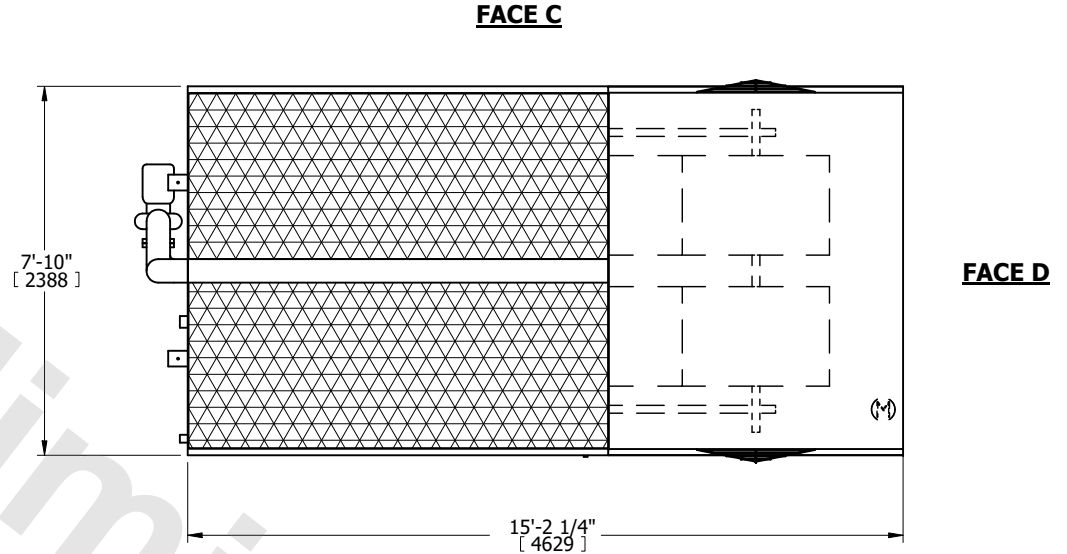

FACE A

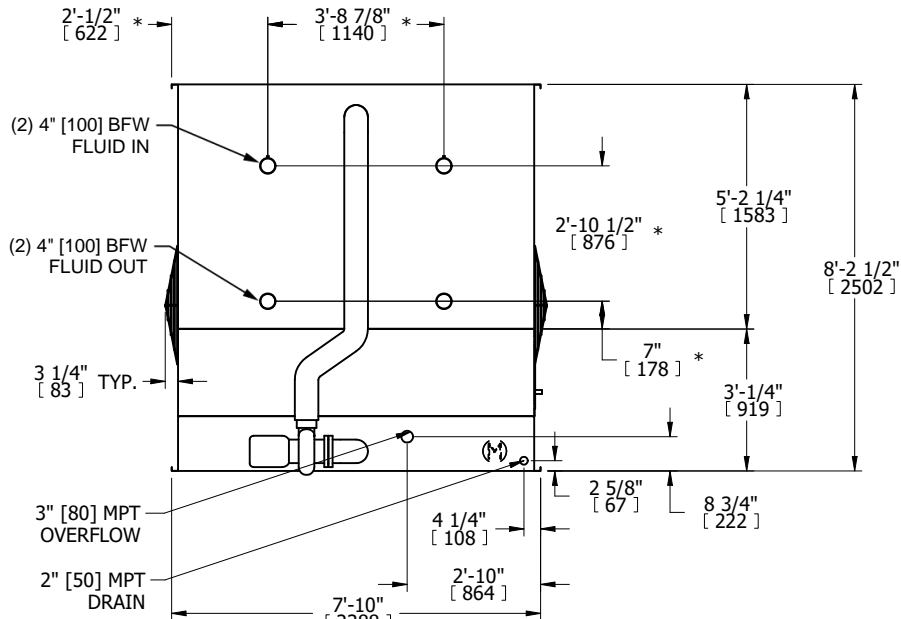

FACE B

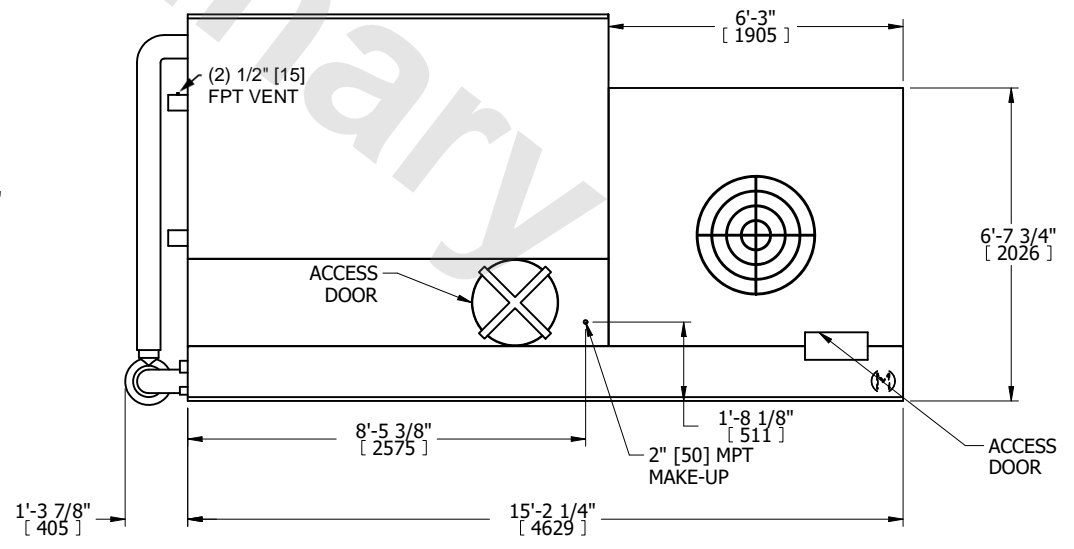

FACE A

SHIPPING WEIGHT	12110 lbs+ [5495] kg+	OPERATING WEIGHT	17550 lbs+ [7965] kg+	HEAVIEST SECTION WEIGHT	12110 lbs+ [5495] kg+	NO. OF SHIPPING SECTIONS	1	DRAWN BY:	TLS
-----------------	-----------------------	------------------	-----------------------	-------------------------	-----------------------	--------------------------	---	-----------	-----