

UNIT	CLOSED CIRCUIT COOLER	
MODEL #	eco-LSWE 8P-3N24-Z	SCALE NTS



DWG. #	WLEP82406-DRD-SF	REV.	-
SERIAL #		DATE	7/5/2026

- NOTES:
- (M)- FAN MOTOR LOCATION
 - MPT DENOTES MALE PIPE THREAD
FPT DENOTES FEMALE PIPE THREAD
BFW DENOTES BEVELED FOR WELDING
GVD DENOTES GROOVED
FLG DENOTES FLANGE
PE DENOTES PLAIN END
 - +UNIT WEIGHT DOES NOT INCLUDE ACCESSORIES (SEE ACCESSORY DRAWINGS)
 - 3/4" [19mm] DIA. MOUNTING HOLES. REFER TO RECOMMENDED STEEL SUPPORT DRAWING
 - DIMENSIONS LISTED AS FOLLOWS: ENGLISH FT IN [METRIC] [mm]
 - * - APPROXIMATE DIMENSIONS DO NOT USE FOR PRE-FABRICATION OF CONNECTING PIPING
 - HEAVIEST SECTION IS COIL SECTION
 - MAKE-UP WATER PRESSURE
20 psi [137 kPa] MIN, 50 psi [344 kPa] MAX
 - SERIES FLOW PIPING AND AUX. CROSSOVER DRAIN ARE BY OTHERS

FACE B
PLAN VIEW

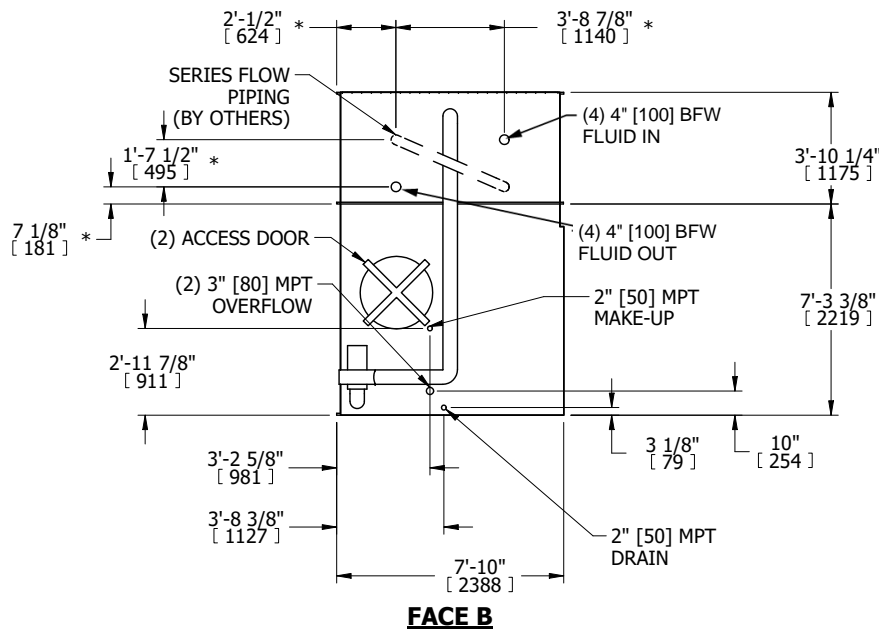
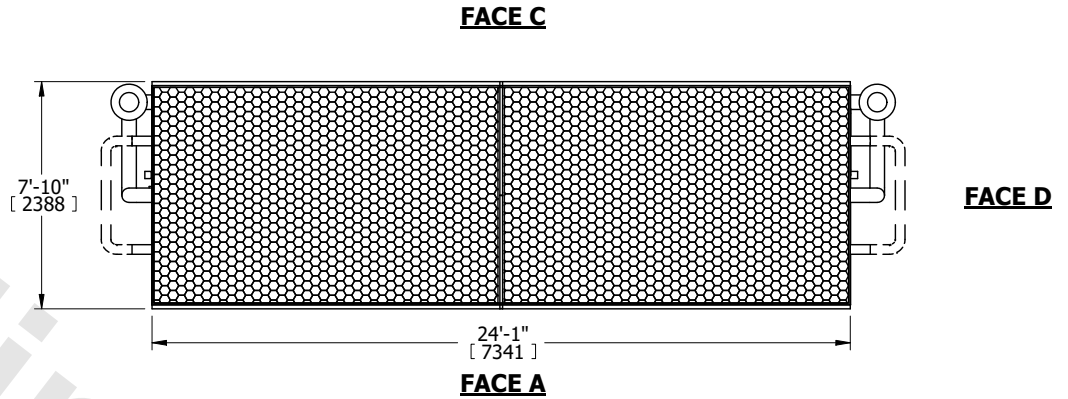

SHIPPING WEIGHT	22600 lbs+ [10255] kg+	OPERATING WEIGHT	32750 lbs+ [14860] kg+	HEAVIEST SECTION WEIGHT	7610 lbs+ [3455] kg+	NO. OF SHIPPING SECTIONS	3	DRAWN BY:	TLS
-----------------	------------------------	------------------	------------------------	-------------------------	----------------------	--------------------------	---	-----------	-----