

|         |                              |           |
|---------|------------------------------|-----------|
| UNIT    | <b>CLOSED CIRCUIT COOLER</b> |           |
| MODEL # | eco-LSWE 10-3K18-Z           | SCALE NTS |

# EVAPCO, INC.

|          |                  |      |          |
|----------|------------------|------|----------|
| DWG. #   | WLETM1806-DRD-SF | REV. | -        |
| SERIAL # |                  | DATE | 9/7/2025 |

- NOTES:
- (M)- FAN MOTOR LOCATION
  - MPT DENOTES MALE PIPE THREAD  
FPT DENOTES FEMALE PIPE THREAD  
BFW DENOTES BEVELED FOR WELDING  
GVD DENOTES GROOVED  
FLG DENOTES FLANGE  
PE DENOTES PLAIN END
  - +UNIT DOES NOT INCLUDE ACCESSORIES (SEE ACCESSORY DRAWINGS)
  - 3/4" [19mm] DIA. MOUNTING HOLES. REFER TO RECOMMENDED STEEL SUPPORT DRAWING
  - DIMENSIONS LISTED AS FOLLOWS: ENGLISH FT IN [METRIC] [mm]
  - \* - APPROXIMATE DIMENSIONS DO NOT USE FOR PRE-FABRICATION OF CONNECTING PIPING
  - HEAVIEST SECTION IS COIL SECTION
  - MAKE-UP WATER PRESSURE  
20 psi [137 kPa] MIN, 50 psi [344 kPa] MAX
  - SERIES FLOW PIPING AND AUX. CROSSOVER DRAIN ARE BY OTHERS

**FACE B**  
**PLAN VIEW**

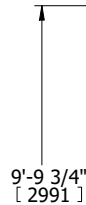

**FACE C**

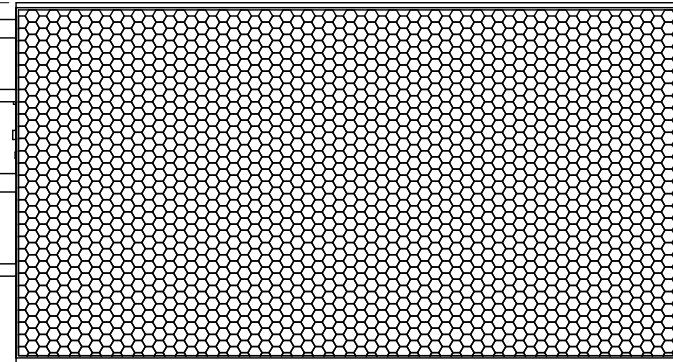

**FACE D**

**FACE A**

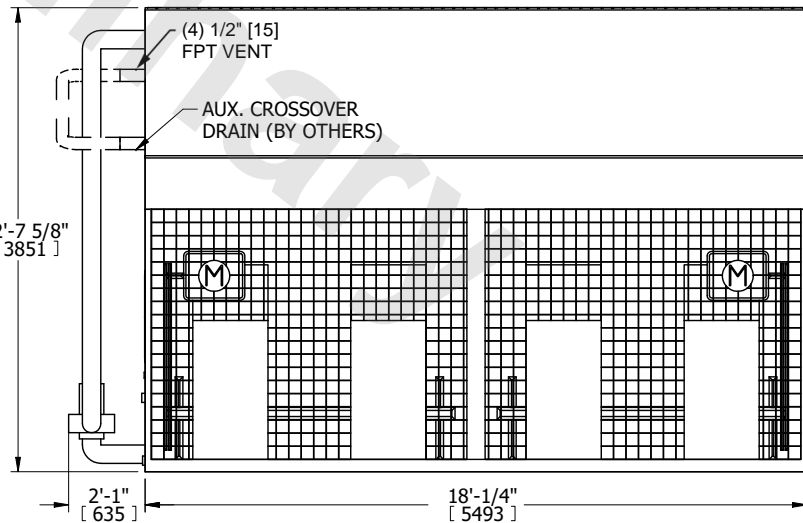
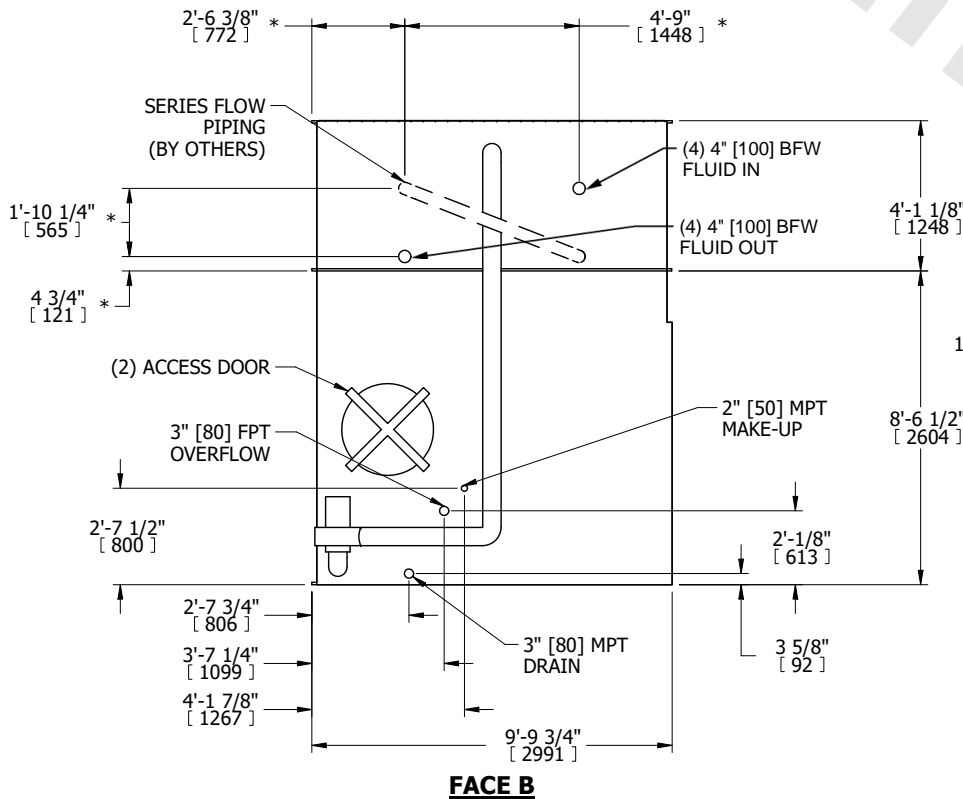

**FACE A**

|                 |                       |                  |                        |                         |                       |                          |   |           |     |
|-----------------|-----------------------|------------------|------------------------|-------------------------|-----------------------|--------------------------|---|-----------|-----|
| SHIPPING WEIGHT | 21950 lbs+ [9960] kg+ | OPERATING WEIGHT | 31700 lbs+ [14380] kg+ | HEAVIEST SECTION WEIGHT | 14820 lbs+ [6725] kg+ | NO. OF SHIPPING SECTIONS | 2 | DRAWN BY: | TLS |
|-----------------|-----------------------|------------------|------------------------|-------------------------|-----------------------|--------------------------|---|-----------|-----|