

|         |                              |
|---------|------------------------------|
| UNIT    | <b>CLOSED CIRCUIT COOLER</b> |
| MODEL # | eco-LSWE 10-4N24-Z           |
| SCALE   | NTS                          |



|          |                  |      |           |
|----------|------------------|------|-----------|
| DWG. #   | WLETM2408-DRD-SF | REV. | -         |
| SERIAL # |                  | DATE | 5/18/2026 |

- NOTES:
- (M)- FAN MOTOR LOCATION
  - MPT DENOTES MALE PIPE THREAD  
FPT DENOTES FEMALE PIPE THREAD  
BFW DENOTES BEVELED FOR WELDING  
GVD DENOTES GROOVED  
FLG DENOTES FLANGE  
PE DENOTES PLAIN END
  - +UNIT WEIGHT DOES NOT INCLUDE ACCESSORIES (SEE ACCESSORY DRAWINGS)
  - 3/4" [19mm] DIA. MOUNTING HOLES. REFER TO RECOMMENDED STEEL SUPPORT DRAWING
  - DIMENSIONS LISTED AS FOLLOWS: ENGLISH FT IN [METRIC] [mm]
  - \* - APPROXIMATE DIMENSIONS DO NOT USE FOR PRE-FABRICATION OF CONNECTING PIPING
  - HEAVIEST SECTION IS COIL SECTION
  - MAKE-UP WATER PRESSURE  
20 psi [137 kPa] MIN, 50 psi [344 kPa] MAX
  - SERIES FLOW PIPING AND AUX. CROSSOVER DRAIN ARE BY OTHERS

**FACE B**  
**PLAN VIEW**

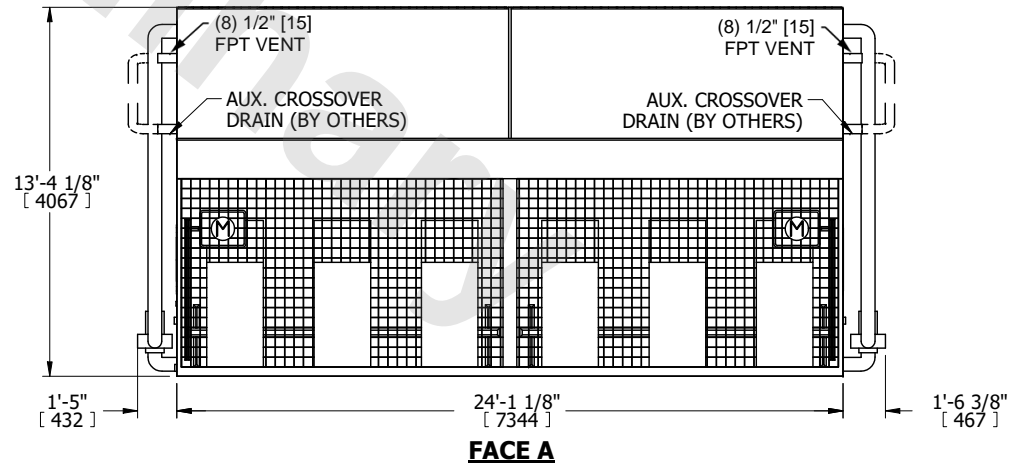
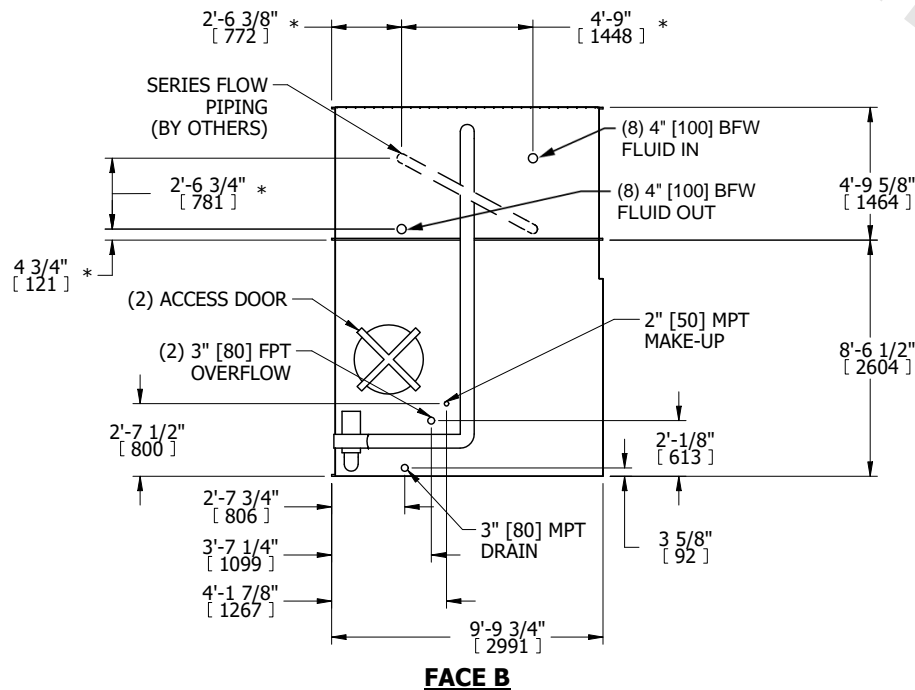
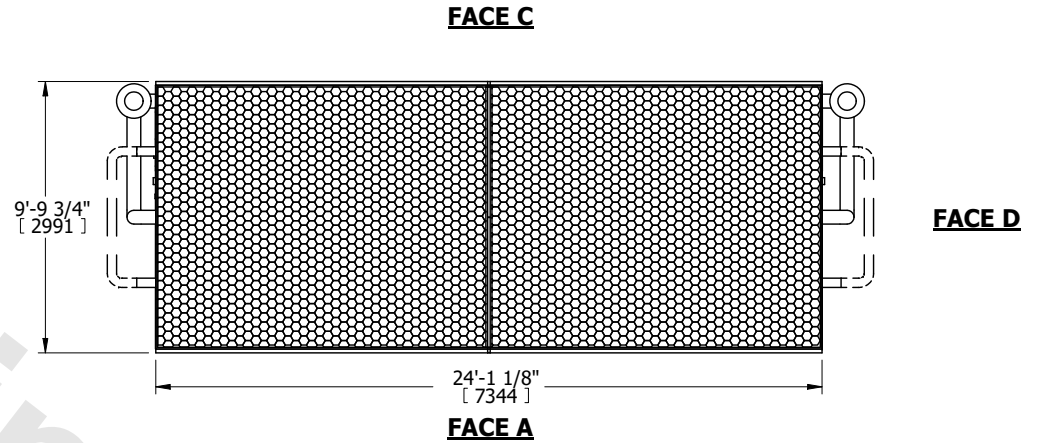

|                 |                        |                  |                        |                         |                       |                          |   |           |     |
|-----------------|------------------------|------------------|------------------------|-------------------------|-----------------------|--------------------------|---|-----------|-----|
| SHIPPING WEIGHT | 34920 lbs+ [15840] kg+ | OPERATING WEIGHT | 49340 lbs+ [22385] kg+ | HEAVIEST SECTION WEIGHT | 12700 lbs+ [5765] kg+ | NO. OF SHIPPING SECTIONS | 3 | DRAWN BY: | TLS |
|-----------------|------------------------|------------------|------------------------|-------------------------|-----------------------|--------------------------|---|-----------|-----|