

UNIT	CLOSED CIRCUIT COOLER	
MODEL #	eco-ATWB 12-4N28	SCALE NTS



DWG. #	WB3122808-DRC-ST	REV.	-
SERIAL #		DATE	7/8/2026

- NOTES:
- (M)- FAN MOTOR LOCATION
  - HEAVIEST SECTION IS UPPER SECTION
  - MPT DENOTES MALE PIPE THREAD  
FPT DENOTES FEMALE PIPE THREAD  
BFW DENOTES BEVELED FOR WELDING  
GVD DENOTES GROOVED  
FLG DENOTES FLANGE  
PE DENOTES PLAIN END
  - +UNIT WEIGHT DOES NOT INCLUDE ACCESSORIES (SEE ACCESSORY DRAWINGS)
  - MAKE-UP WATER PRESSURE  
20 psi MIN [137 kPa], 50 psi MAX [344 kPa]
  - \*-APPROXIMATE DIMENSIONS DO NOT USE FOR PRE-FABRICATION OF CONNECTING PIPING
  - 3/4" [19mm] DIA. MOUNTING HOLES. REFER TO RECOMMENDED STEEL SUPPORT DRAWING.
  - DIMENSIONS LISTED AS FOLLOWS:  
ENGLISH FT-IN  
METRIC [mm]

**FACE B**  
**PLAN VIEW**



**FACE A**

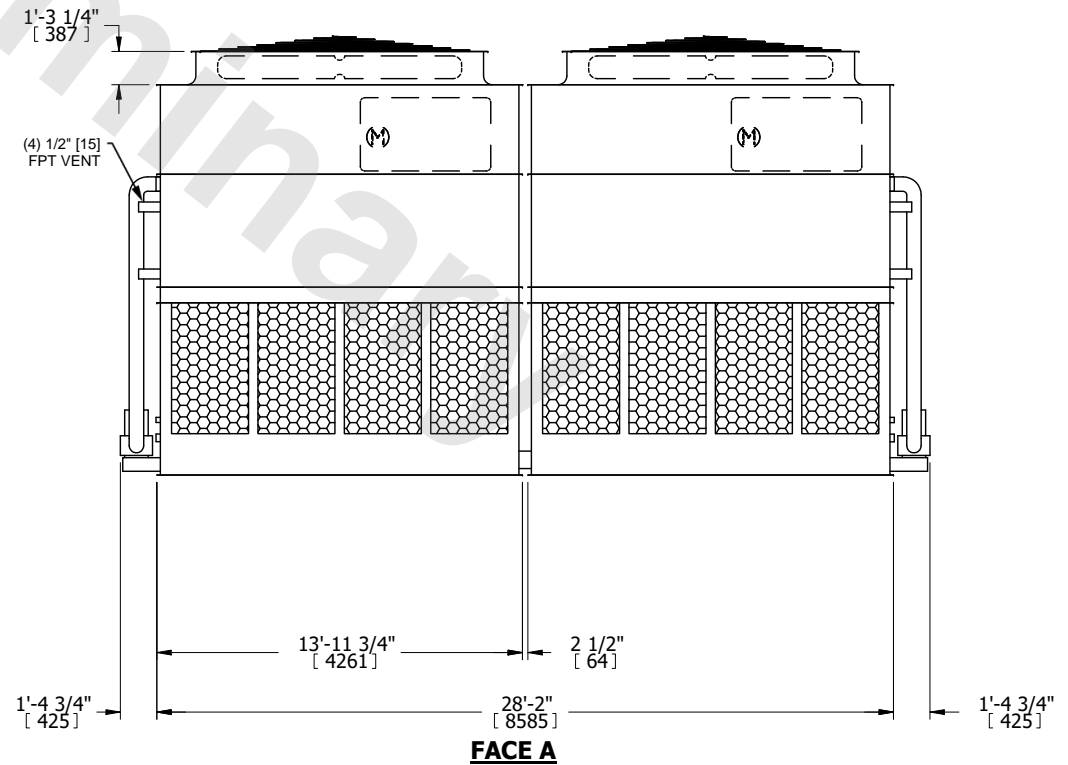
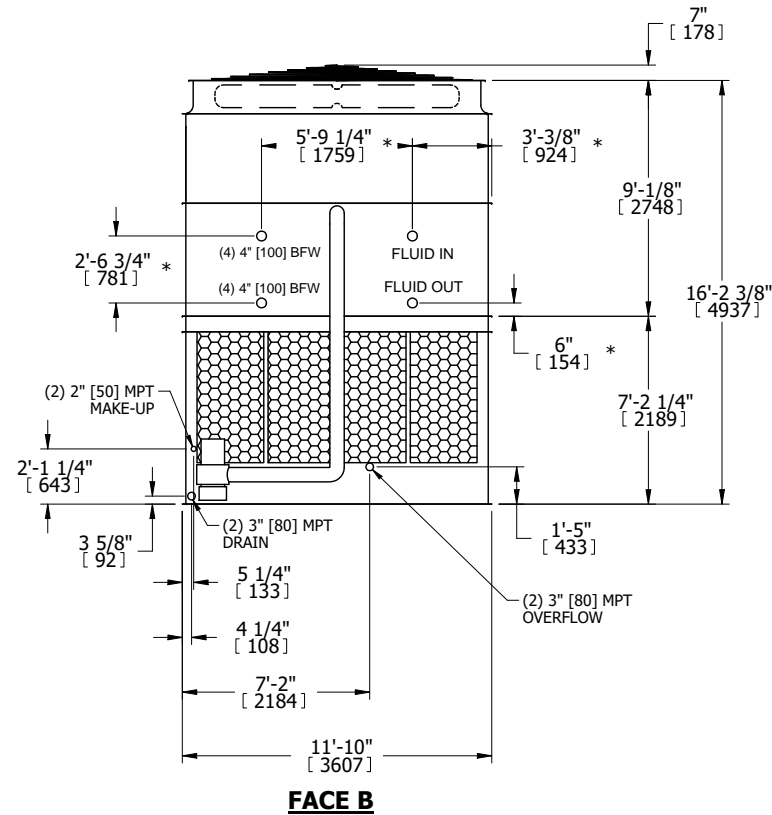

SHIPPING WEIGHT	46640 lbs+ [21160] kg+	OPERATING WEIGHT	68700 lbs+ [31165] kg+	HEAVIEST SECTION WEIGHT	20260 lbs+ [9190] kg+	NO. OF SHIPPING SECTIONS	4	DRAWN BY:	SLR
-----------------	------------------------	------------------	------------------------	-------------------------	-----------------------	--------------------------	---	-----------	-----