

UNIT	CLOSED CIRCUIT COOLER	
MODEL #	eco-ATWB 4-4E9-Z	SCALE NTS



DWG. #	WB3040908-DRE-SF	REV.	-
SERIAL #		DATE	5/19/2026

NOTES:

- (M)- FAN MOTOR LOCATION
- HEAVIEST SECTION IS UPPER SECTION
- MPT DENOTES MALE PIPE THREAD
FPT DENOTES FEMALE PIPE THREAD
BFW DENOTES BEVELED FOR WELDING
GVD DENOTES GROOVED
FLG DENOTES FLANGE
PE DENOTES PLAIN END
- +UNIT WEIGHT DOES NOT INCLUDE ACCESSORIES (SEE ACCESSORY DRAWINGS)
- MAKE-UP WATER PRESSURE
20 psi MIN [137 kPa], 50 psi MAX [344 kPa]
- *-APPROXIMATE DIMENSIONS DO NOT USE FOR PRE-FABRICATION OF CONNECTING PIPING
- SERIES FLOW PIPING AND AUX. CROSSOVER DRAIN BY OTHERS.
- 3/4" [19MM] DIA. MOUNTING HOLES. REFER TO RECOMMENDED STEEL SUPPORT DRAWING.
- DIMENSIONS LISTED AS FOLLOWS:
ENGLISH FT-IN
[METRIC] MM

**FACE B
PLAN VIEW**

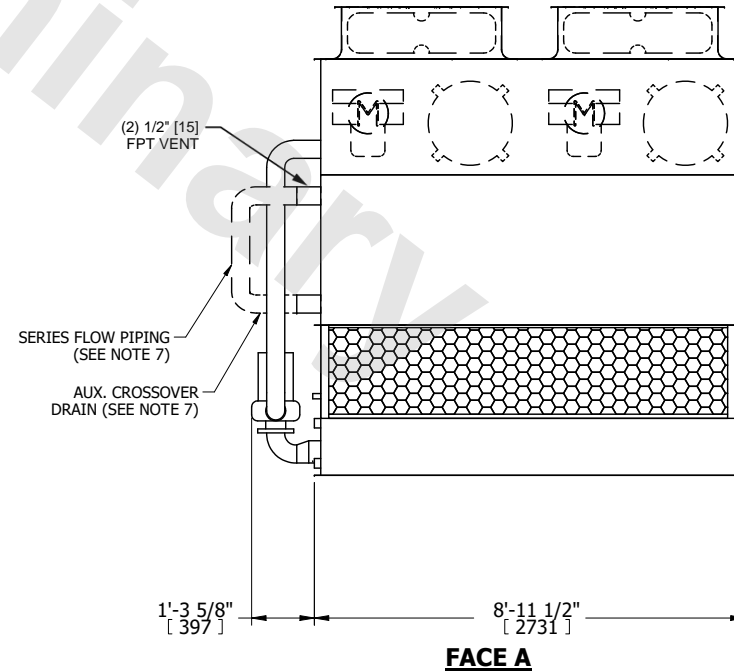
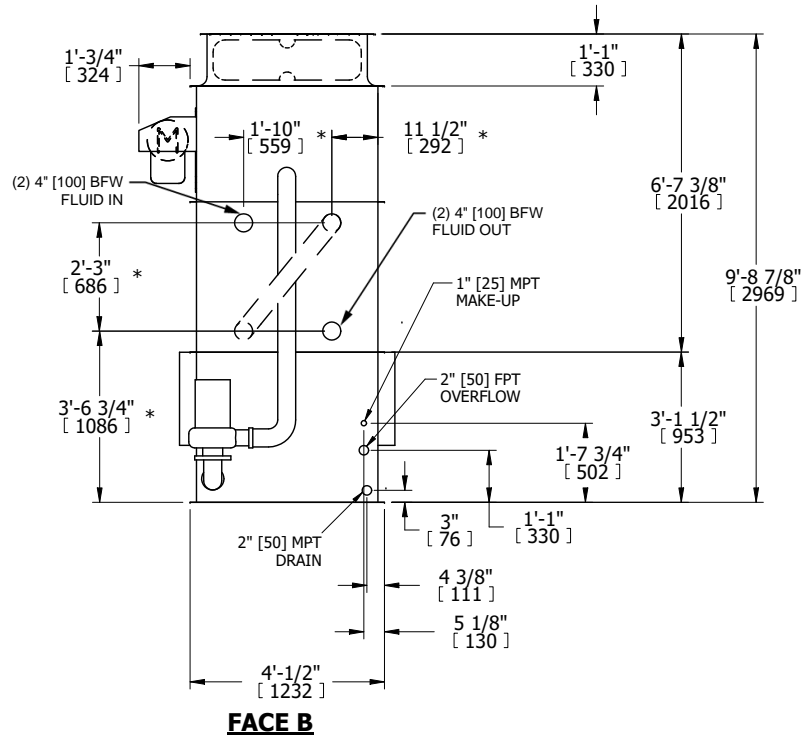
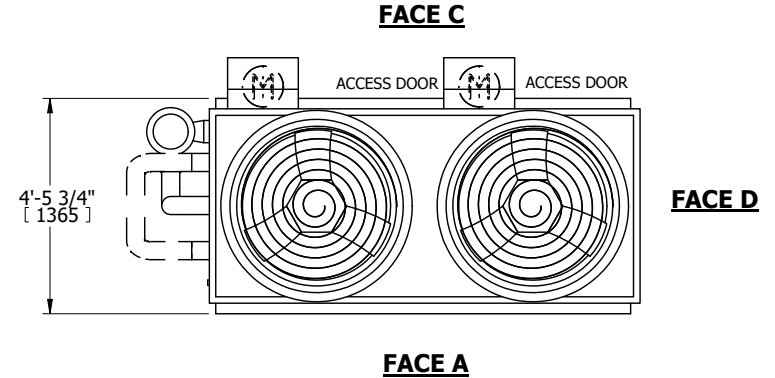

SHIPPING WEIGHT	5460 lbs+ [2480] kg+	OPERATING WEIGHT	7850 lbs+ [3565] kg+	HEAVIEST SECTION WEIGHT	4790 lbs+ [2175] kg+	NO. OF SHIPPING SECTIONS	2	DRAWN BY:	CAF
-----------------	----------------------	------------------	----------------------	-------------------------	----------------------	--------------------------	---	-----------	-----