

UNIT	CLOSED CIRCUIT COOLER	
MODEL #	eco-ATWB 12-4N18-Z	SCALE NTS

# EVAPCO, INC.

DWG. #	WB3121808-DRC-SF	REV.	-
SERIAL #		DATE	7/8/2026

- NOTES:
- (M) - FAN MOTOR LOCATION
  - HEAVIEST SECTION IS UPPER SECTION
  - MPT DENOTES MALE PIPE THREAD  
FPT DENOTES FEMALE PIPE THREAD  
BFW DENOTES BEVELED FOR WELDING  
GVD DENOTES GROOVED  
FLG DENOTES FLANGE  
PE DENOTES PLAIN END
  - + UNIT WEIGHT DOES NOT INCLUDE ACCESSORIES (SEE SEPARATE DRAWINGS FOR ACCESSORIES)
  - MAKE-UP WATER PRESSURE  
20 psi MIN [137 kPa], 50 psi MAX [344 kPa]
  - \* - APPROXIMATE DIMENSIONS DO NOT USE FOR PRE-FABRICATION OF CONNECTING PIPING
  - SERIES FLOW PIPING AND AUX. CROSSOVER DRAIN BY OTHERS
  - 3/4" [19MM] DIA. MOUNTING HOLES. REFER TO RECOMMENDED STEEL SUPPORT DRAWING.
  - DIMENSIONS LISTED AS FOLLOWS:  
ENGLISH FT-IN  
METRIC [mm]

**FACE B  
PLAN VIEW**

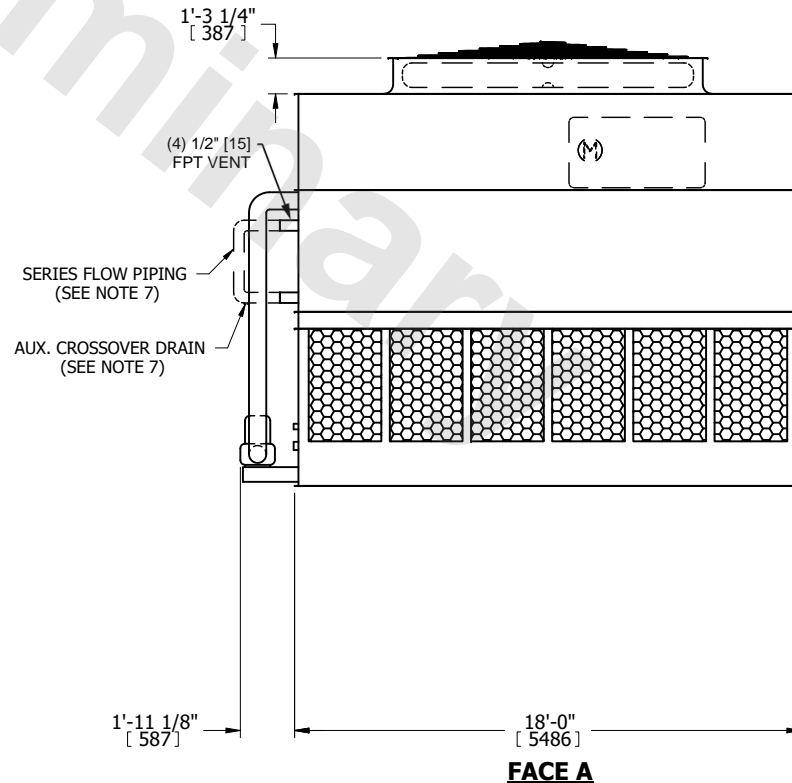
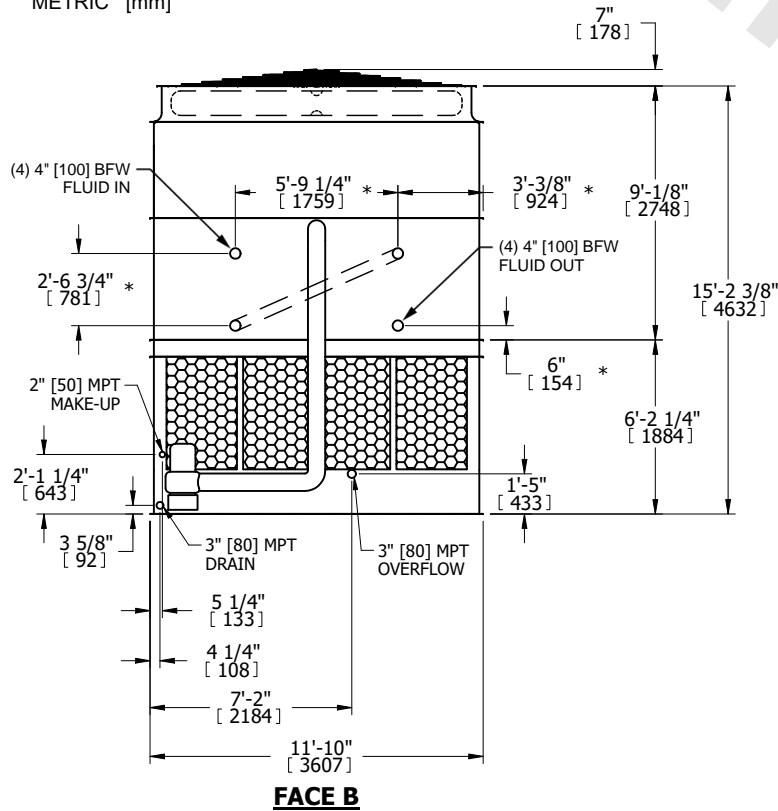
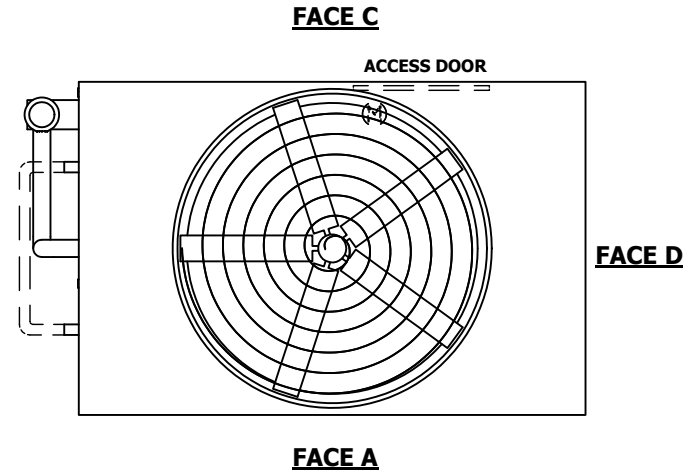

SHIPPING WEIGHT	29300 lbs+ [13295] kg+	OPERATING WEIGHT	43470 lbs+ [19720] kg+	HEAVIEST SECTION WEIGHT	25380 lbs+ [11515] kg+	NO. OF SHIPPING SECTIONS	2	DRAWN BY:	JLG
-----------------	------------------------	------------------	------------------------	-------------------------	------------------------	--------------------------	---	-----------	-----