

EVAPCO, INC.



UNIT CLOSED CIRCUIT COOLER	MODEL # eco-ATWB-H 9-4K12-U12	SCALE N.T.S	DWG. # EGH0912MR-DRC-ST	REV. -	DATE 6/13/2026	SERIAL #
-------------------------------	----------------------------------	----------------	----------------------------	-----------	-------------------	----------

- NOTES:
- (M)- FAN MOTOR LOCATION
 - HEAVIEST SECTION IS COIL SECTION
 - MPT DENOTES MALE PIPE THREAD
FPT DENOTES FEMALE PIPE THREAD
BFW DENOTES BEVELED FOR WELDING
 - +UNIT WEIGHT DOES NOT INCLUDE ACCESSORIES (SEE ACCESSORY DRAWINGS)
 - MAKE-UP WATER PRESSURE
20 psi MIN [137 kPa], 50 psi MAX [344 kPa]

- DIMENSIONS LISTED AS FOLLOWS:
ENGLISH IN
[METRIC] [mm]
- * - APPROXIMATE DIMENSIONS DO NOT USE FOR PRE-FABRICATION OF CONNECTING PIPING.

**FACE 2
PLAN VIEW**



FACE 1



FACE 2

(2) 1/2 [15] FPT VENT
CROSSOVER PIPING

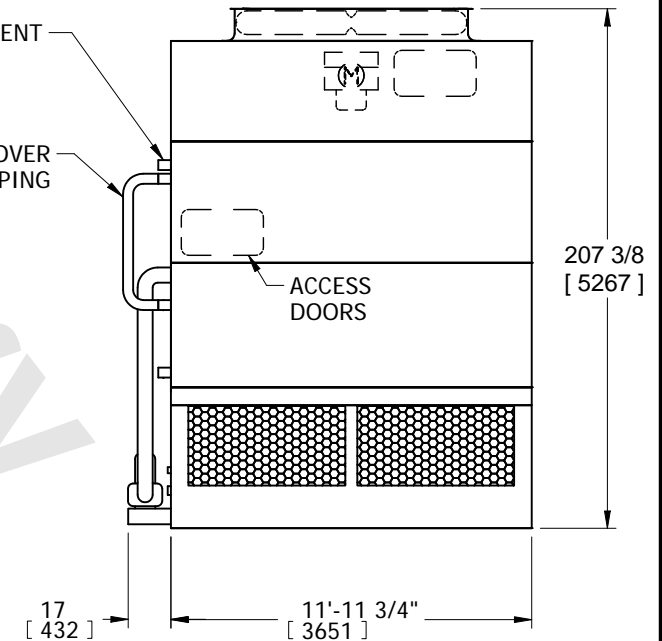

FACE 1

SHIPPING WEIGHT 16660 lbs+ [7560] kg+	OPERATING WEIGHT 22510 lbs+ [10215] kg+	HEAVIEST SECTION WEIGHT 12320 lbs+ [5585] kg+	NO. OF SHIPPING SECTIONS 3	DRAWN BY: SFR
--	--	--	-------------------------------	------------------