

# EVAPCO, INC.



|                               |                                   |                 |                            |           |                   |          |
|-------------------------------|-----------------------------------|-----------------|----------------------------|-----------|-------------------|----------|
| UNIT<br>CLOSED CIRCUIT COOLER | MODEL #<br>eco-ATWB-H 12-2L24-U44 | SCALE<br>N.T.S. | DWG. #<br>EGH1224MR-DRB-ST | REV.<br>- | DATE<br>4/29/2026 | SERIAL # |
|-------------------------------|-----------------------------------|-----------------|----------------------------|-----------|-------------------|----------|

- NOTES:
- (M)- FAN MOTOR LOCATION
  - HEAVIEST SECTION IS COIL SECTION
  - MPT DENOTES MALE PIPE THREAD  
FPT DENOTES FEMALE PIPE THREAD  
BFW DENOTES BEVELED FOR WELDING
  - +UNIT WEIGHT DOES NOT INCLUDE ACCESSORIES (SEE ACCESSORY DRAWINGS)
  - MAKE-UP WATER PRESSURE  
20 psi MIN [137 kPa], 50 psi MAX [344 kPa]

- DIMENSIONS LISTED AS FOLLOWS:  
ENGLISH IN  
[METRIC] [mm]
- \* - APPROXIMATE DIMENSIONS DO NOT USE FOR PRE-FABRICATION OF CONNECTING PIPING.

**FACE 2  
PLAN VIEW**



**FACE 1**

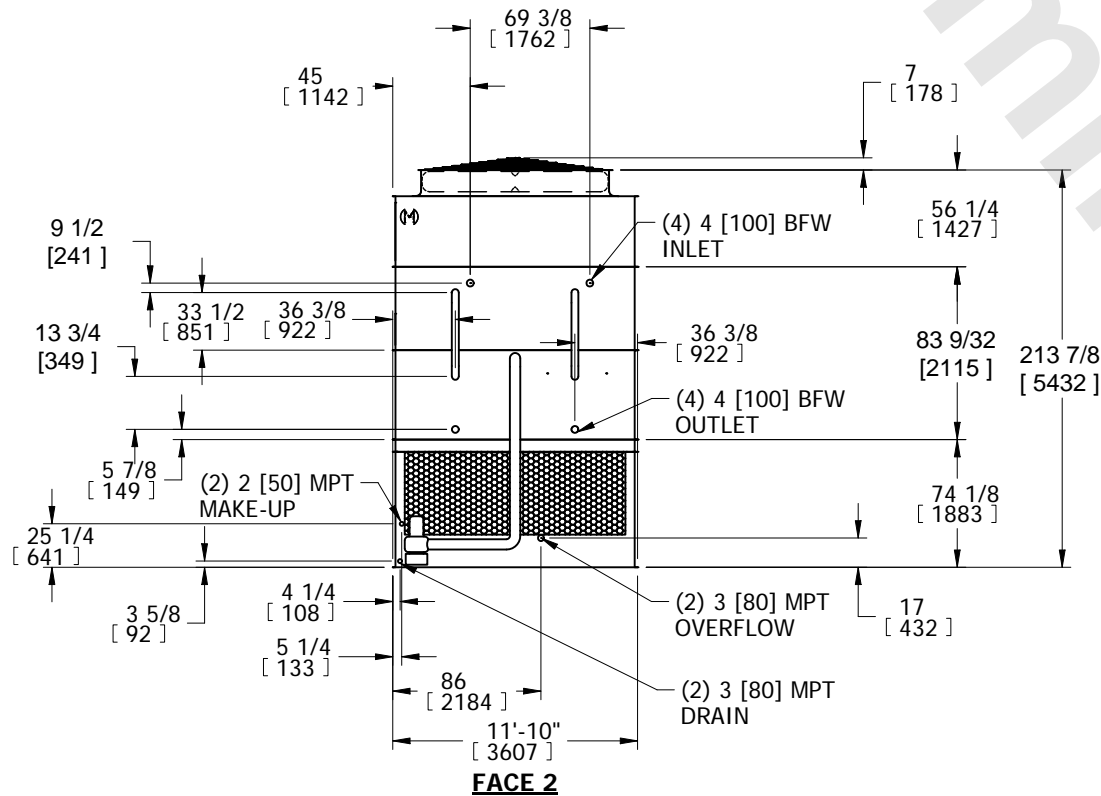

(4) 1/2 [15] FPT VENT

CROSSOVER PIPING

ACCESS DOORS

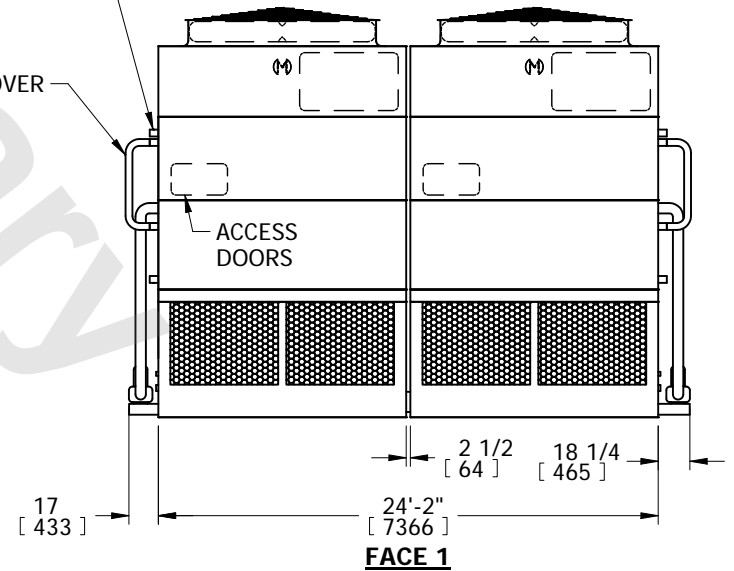

**FACE 1**

|   |  |  |                               |                  |
|---|--|--|-------------------------------|------------------|
| SHIPPING WEIGHT<br>39430 lbs+ [17890] kg+ | OPERATING WEIGHT<br>55710 lbs+ [25270] kg+ | HEAVIEST SECTION WEIGHT<br>14090 lbs+ [6390] kg+ | NO. OF SHIPPING SECTIONS<br>6 | DRAWN BY:<br>SFR |
|---|--|--|-------------------------------|------------------|