

# EVAPCO, INC.



|                               |                                     |                 |                            |           |                   |          |
|-------------------------------|-------------------------------------|-----------------|----------------------------|-----------|-------------------|----------|
| UNIT<br>CLOSED CIRCUIT COOLER | MODEL #<br>eco-ATWB-H 12-3N18-Z-U34 | SCALE<br>N.T.S. | DWG. #<br>EGH1218MR-DRB-SF | REV.<br>- | DATE<br>4/30/2026 | SERIAL # |
|-------------------------------|-------------------------------------|-----------------|----------------------------|-----------|-------------------|----------|

- NOTES:
- (M)- FAN MOTOR LOCATION
  - HEAVIEST SECTION IS COIL SECTION
  - MPT DENOTES MALE PIPE THREAD  
FPT DENOTES FEMALE PIPE THREAD  
BFW DENOTES BEVELED FOR WELDING
  - +UNIT WEIGHT DOES NOT INCLUDE ACCESSORIES (SEE ACCESSORY DRAWINGS)
  - MAKE-UP WATER PRESSURE  
20 psi MIN [137 kPa], 50 psi MAX [344 kPa]

- DIMENSIONS LISTED AS FOLLOWS:  
ENGLISH IN  
[METRIC] [mm]
- \* - APPROXIMATE DIMENSIONS DO NOT USE FOR PRE-FABRICATION OF CONNECTING PIPING.

**FACE 2  
PLAN VIEW**

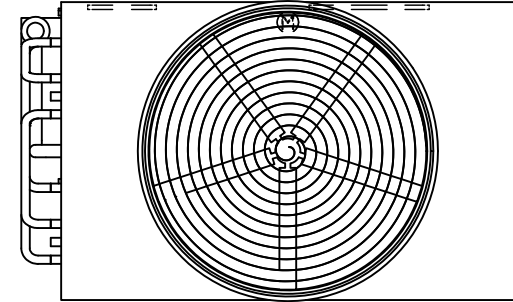

**FACE 1**

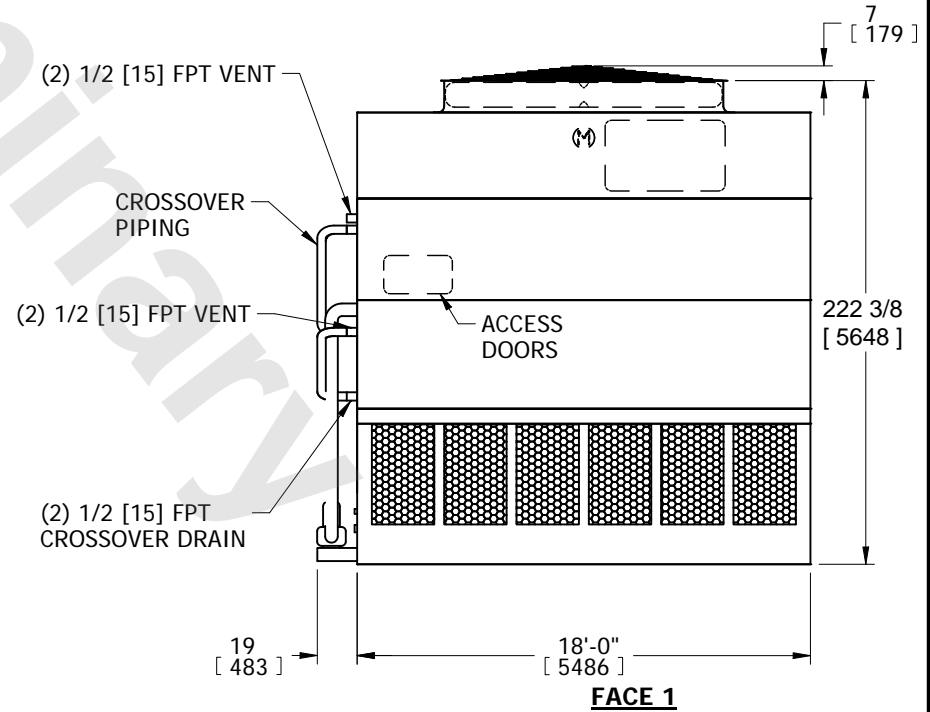
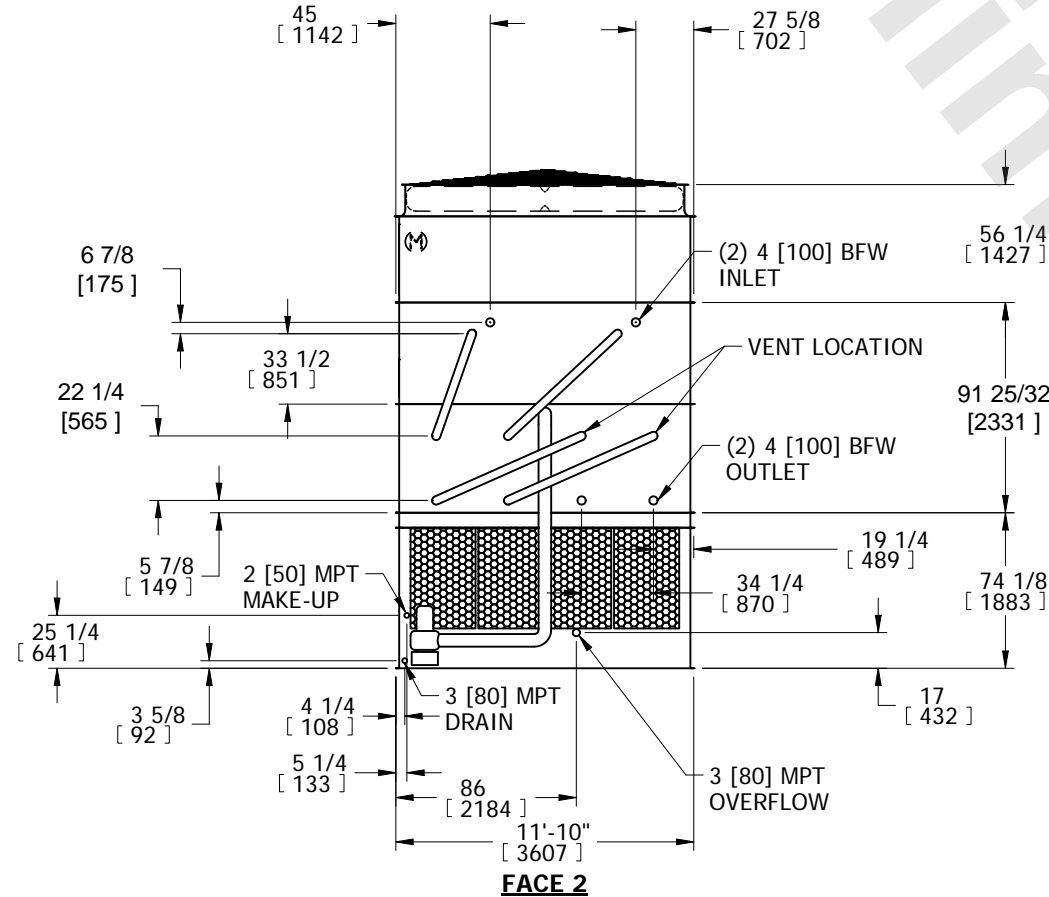

|   |  |   |                               |                  |
|---|--|---|-------------------------------|------------------|
| SHIPPING WEIGHT<br>31670 lbs+ [14370] kg+ | OPERATING WEIGHT<br>44710 lbs+ [20285] kg+ | HEAVIEST SECTION WEIGHT<br>23840 lbs+ [10815] kg+ | NO. OF SHIPPING SECTIONS<br>3 | DRAWN BY:<br>SFR |
|---|--|---|-------------------------------|------------------|