

# EVAPCO, INC.



|                               |                                   |                 |                            |           |                   |          |
|-------------------------------|-----------------------------------|-----------------|----------------------------|-----------|-------------------|----------|
| UNIT<br>CLOSED CIRCUIT COOLER | MODEL #<br>eco-ATWB-H 20-4N18-U34 | SCALE<br>N.T.S. | DWG. #<br>EGH6M18MR-DRD-ST | REV.<br>- | DATE<br>6/20/2026 | SERIAL # |
|-------------------------------|-----------------------------------|-----------------|----------------------------|-----------|-------------------|----------|

- NOTES:
- (M)- FAN MOTOR LOCATION
  - HEAVIEST SECTION IS COIL SECTION
  - MPT DENOTES MALE PIPE THREAD  
FPT DENOTES FEMALE PIPE THREAD  
BFW DENOTES BEVELED FOR WELDING
  - +UNIT WEIGHT DOES NOT INCLUDE ACCESSORIES (SEE ACCESSORY DRAWINGS)
  - MAKE-UP WATER PRESSURE  
20 psi MIN [137 kPa], 50 psi MAX [344 kPa]

- DIMENSIONS LISTED AS FOLLOWS:  
ENGLISH IN  
[METRIC] [mm]
- \* - APPROXIMATE DIMENSIONS DO NOT USE FOR PRE-FABRICATION OF CONNECTING PIPING.



**FACE 2  
PLAN VIEW**

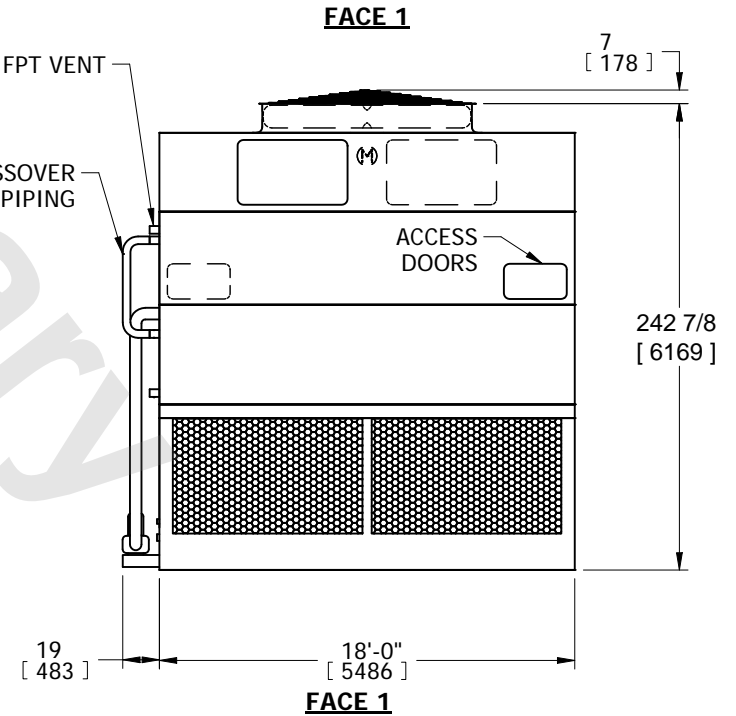
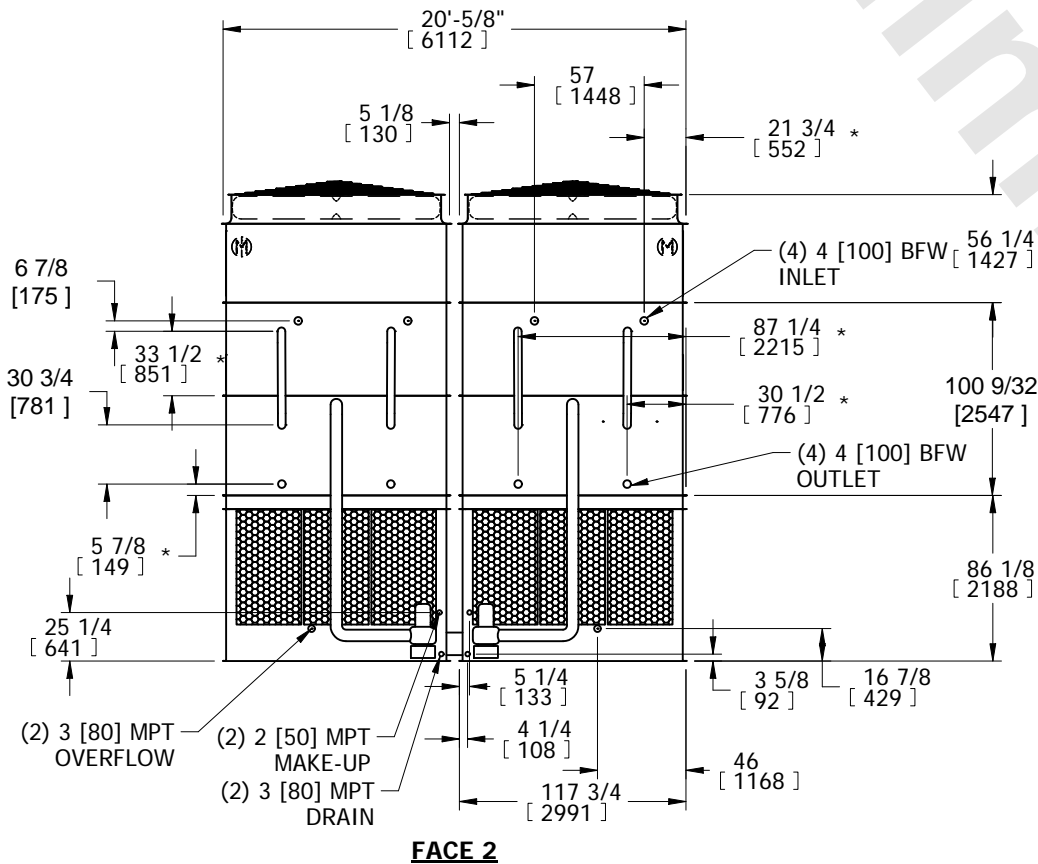

|   |  |   |                               |                  |
|---|--|---|-------------------------------|------------------|
| SHIPPING WEIGHT<br>62970 lbs+ [28565] kg+ | OPERATING WEIGHT<br>87170 lbs+ [39540] kg+ | HEAVIEST SECTION WEIGHT<br>24280 lbs+ [11015] kg+ | NO. OF SHIPPING SECTIONS<br>6 | DRAWN BY:<br>SFR |
|---|--|---|-------------------------------|------------------|