

EVAPCO, INC.



UNIT CLOSED CIRCUIT COOLER	MODEL # eco-ATWB-H 12-3L36-U34	SCALE N.T.S.	DWG. # EGH1236MR-DRD-ST	REV. -	DATE 6/23/2026	SERIAL #
-------------------------------	-----------------------------------	-----------------	----------------------------	-----------	-------------------	----------

- NOTES:
- (M)- FAN MOTOR LOCATION
 - HEAVIEST SECTION IS COIL SECTION
 - MPT DENOTES MALE PIPE THREAD
FPT DENOTES FEMALE PIPE THREAD
BFW DENOTES BEVELED FOR WELDING
 - +UNIT WEIGHT DOES NOT INCLUDE ACCESSORIES (SEE ACCESSORY DRAWINGS)
 - MAKE-UP WATER PRESSURE
20 psi MIN [137 kPa], 50 psi MAX [344 kPa]

- DIMENSIONS LISTED AS FOLLOWS:
ENGLISH IN
[METRIC] [mm]
- * - APPROXIMATE DIMENSIONS DO NOT USE FOR PRE-FABRICATION OF CONNECTING PIPING.

**FACE 2
PLAN VIEW**



FACE 1

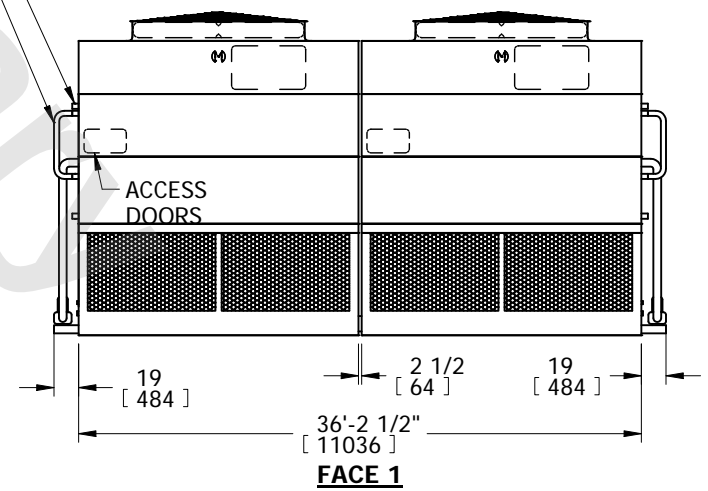
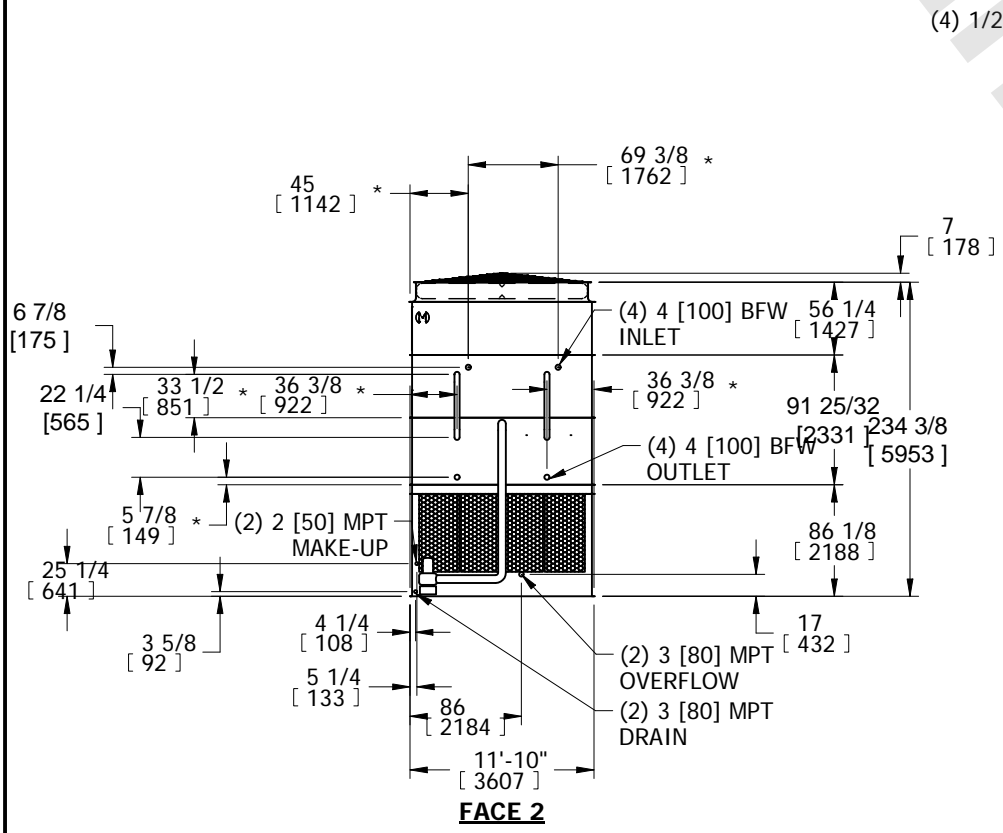

SHIPPING WEIGHT 62920 lbs+ [28545] kg+	OPERATING WEIGHT 89000 lbs+ [40370] kg+	HEAVIEST SECTION WEIGHT 23840 lbs+ [10815] kg+	NO. OF SHIPPING SECTIONS 6	DRAWN BY: SFR
---	--	---	-------------------------------	------------------