

EVAPCO, INC.



| | | | | | | |
|-------------------------------|-------------------------------------|-----------------|----------------------------|-----------|-------------------|----------|
| UNIT CLOSED CIRCUIT COOLER | MODEL # eco-ATWB-H 12-2L24-Z-U44 | SCALE N.T.S. | DWG. # EGH1224MR-DRB-SF | REV. - | DATE 4/29/2026 | SERIAL # |
|-------------------------------|-------------------------------------|-----------------|----------------------------|-----------|-------------------|----------|

- NOTES:
- (M)- FAN MOTOR LOCATION
 - HEAVIEST SECTION IS COIL SECTION
 - MPT DENOTES MALE PIPE THREAD
FPT DENOTES FEMALE PIPE THREAD
BFW DENOTES BEVELED FOR WELDING
 - +UNIT WEIGHT DOES NOT INCLUDE ACCESSORIES (SEE ACCESSORY DRAWINGS)
 - MAKE-UP WATER PRESSURE
20 psi MIN [137 kPa], 50 psi MAX [344 kPa]

- DIMENSIONS LISTED AS FOLLOWS:
ENGLISH IN
[METRIC] [mm]
- * - APPROXIMATE DIMENSIONS DO NOT USE FOR PRE-FABRICATION OF CONNECTING PIPING.

**FACE 2
PLAN VIEW**



FACE 1

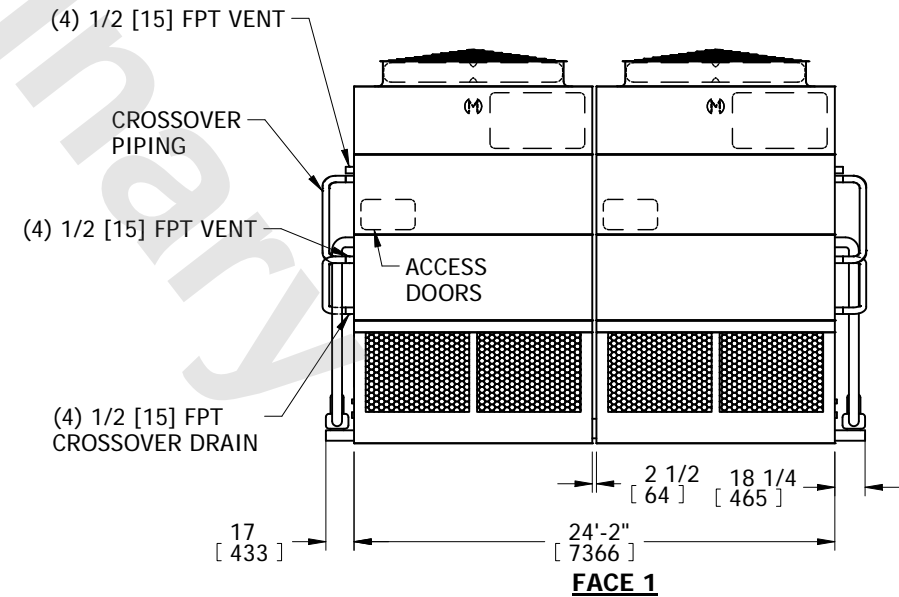
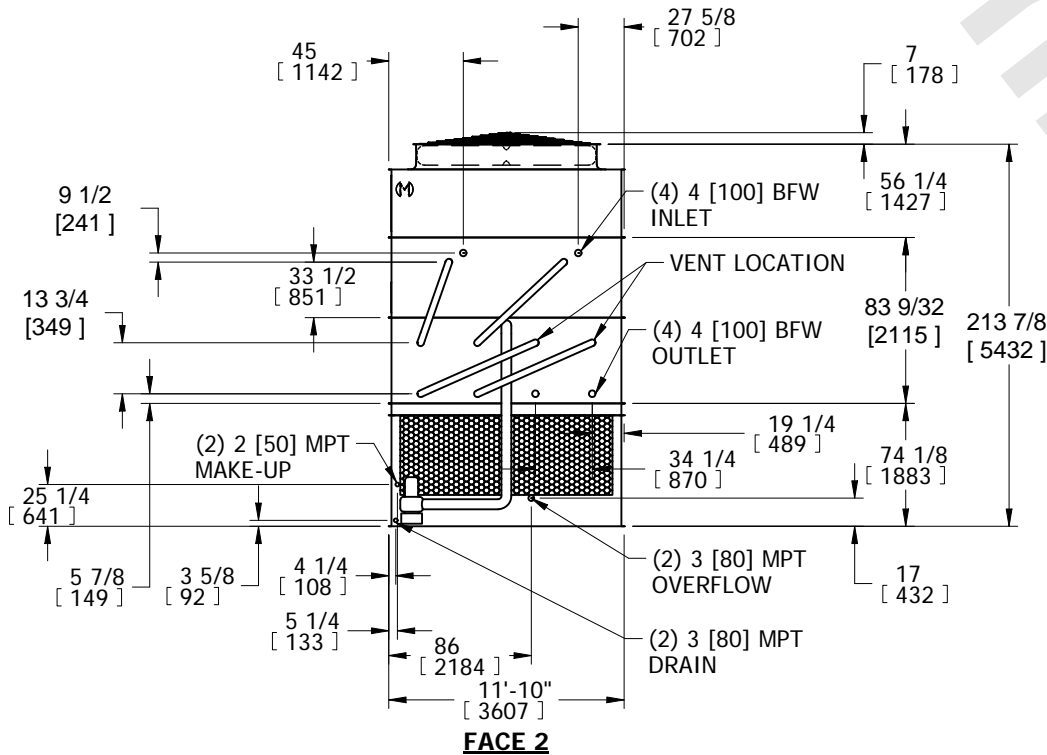

| | | | | |
|---|--|--|-------------------------------|------------------|
| SHIPPING WEIGHT 39430 lbs+ [17890] kg+ | OPERATING WEIGHT 55710 lbs+ [25270] kg+ | HEAVIEST SECTION WEIGHT 14090 lbs+ [6390] kg+ | NO. OF SHIPPING SECTIONS 6 | DRAWN BY: SFR |
|---|--|--|-------------------------------|------------------|