

# EVAPCO, INC.



UNIT CLOSED CIRCUIT COOLER	MODEL # eco-ATWB-H 9-3112-Z-U12	SCALE N.T.S	DWG. # EGH0912MR-DRC-SF	REV. -	DATE 4/27/2026	SERIAL #
-------------------------------	------------------------------------	----------------	----------------------------	-----------	-------------------	----------

- NOTES:
- (M)- FAN MOTOR LOCATION
  - HEAVIEST SECTION IS COIL SECTION
  - MPT DENOTES MALE PIPE THREAD  
FPT DENOTES FEMALE PIPE THREAD  
BFW DENOTES BEVELED FOR WELDING
  - +UNIT WEIGHT DOES NOT INCLUDE ACCESSORIES (SEE ACCESSORY DRAWINGS)
  - MAKE-UP WATER PRESSURE  
20 psi MIN [137 kPa], 50 psi MAX [344 kPa]

- DIMENSIONS LISTED AS FOLLOWS:  
ENGLISH IN  
[METRIC] [mm]
- \* - APPROXIMATE DIMENSIONS DO NOT USE FOR PRE-FABRICATION OF CONNECTING PIPING.

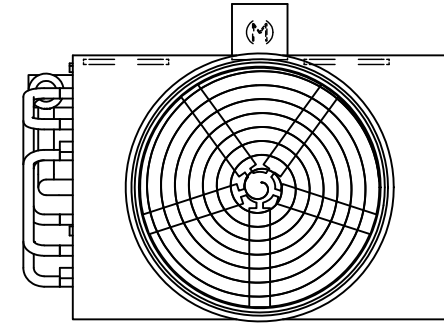

**FACE 2  
PLAN VIEW**

**FACE 1**

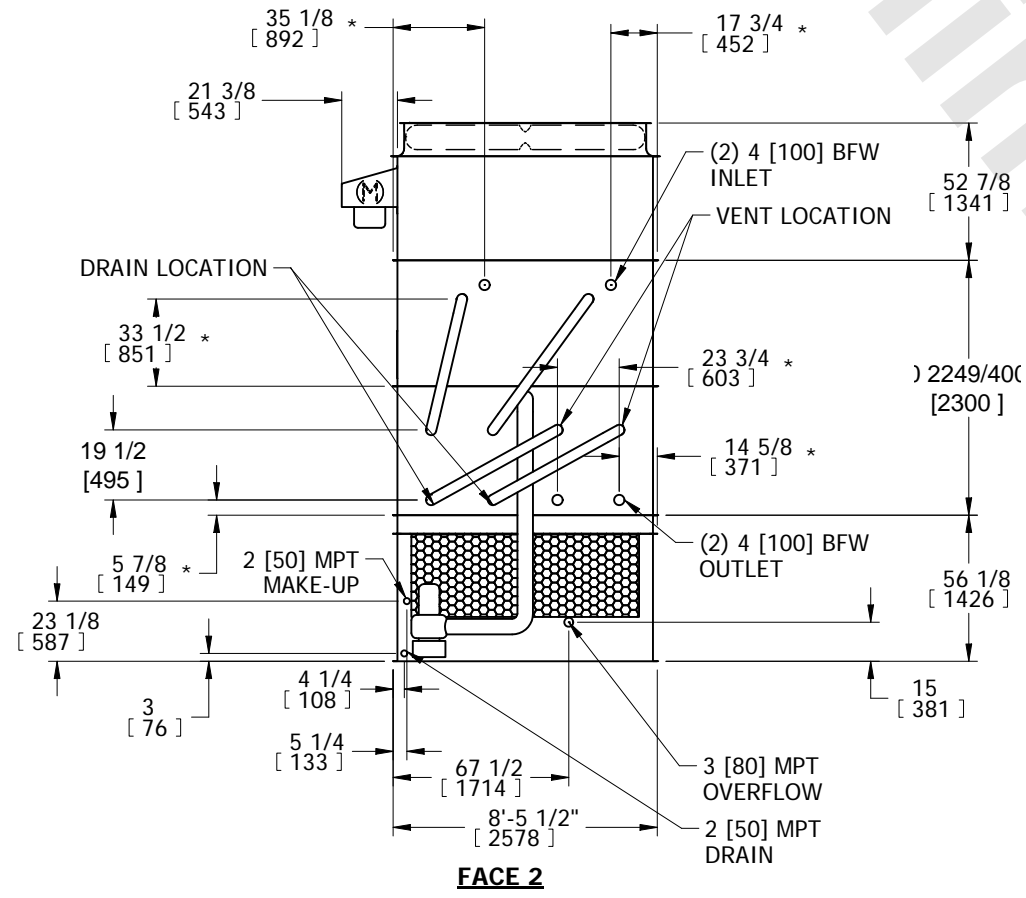

**FACE 2**

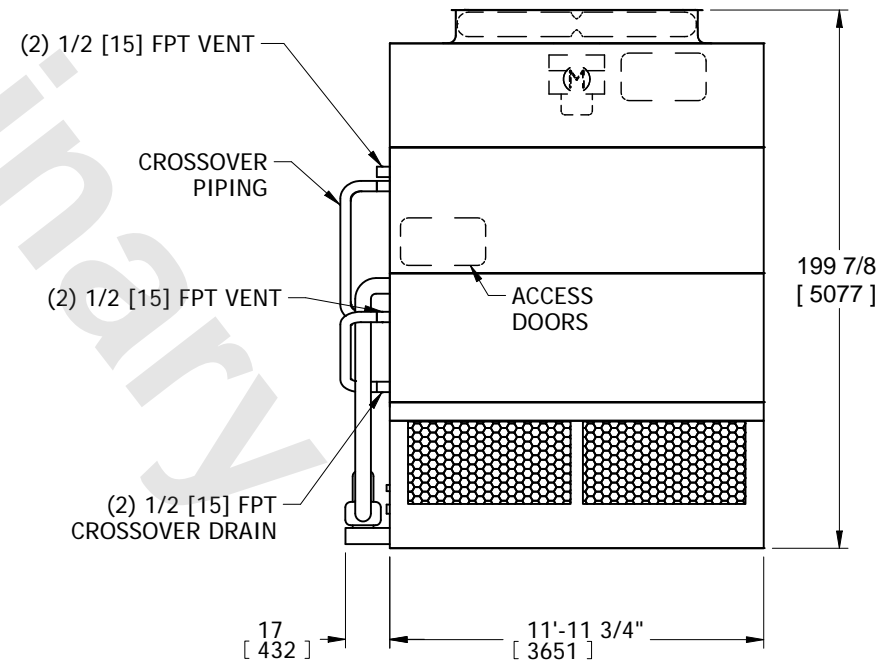

**FACE 1**

SHIPPING WEIGHT 14280 lbs+ [6480] kg+	OPERATING WEIGHT 19570 lbs+ [8880] kg+	HEAVIEST SECTION WEIGHT 10130 lbs+ [4595] kg+	NO. OF SHIPPING SECTIONS 3	DRAWN BY: SFR
--	---	--	-------------------------------	------------------