

EVAPCO, INC.



UNIT CLOSED CIRCUIT COOLER	MODEL # eco-ATWB-H 20-4118-U34	SCALE N.T.S.	DWG. # EGH6M18MR-DRD-ST	REV. -	DATE 4/30/2026	SERIAL #
-------------------------------	-----------------------------------	-----------------	----------------------------	-----------	-------------------	----------

- NOTES:
- (M)- FAN MOTOR LOCATION
 - HEAVIEST SECTION IS COIL SECTION
 - MPT DENOTES MALE PIPE THREAD
FPT DENOTES FEMALE PIPE THREAD
BFW DENOTES BEVELED FOR WELDING
 - +UNIT WEIGHT DOES NOT INCLUDE ACCESSORIES (SEE ACCESSORY DRAWINGS)
 - MAKE-UP WATER PRESSURE
20 psi MIN [137 kPa], 50 psi MAX [344 kPa]

- DIMENSIONS LISTED AS FOLLOWS:
ENGLISH IN
[METRIC] [mm]
- * - APPROXIMATE DIMENSIONS DO NOT USE FOR PRE-FABRICATION OF CONNECTING PIPING.



**FACE 2
PLAN VIEW**

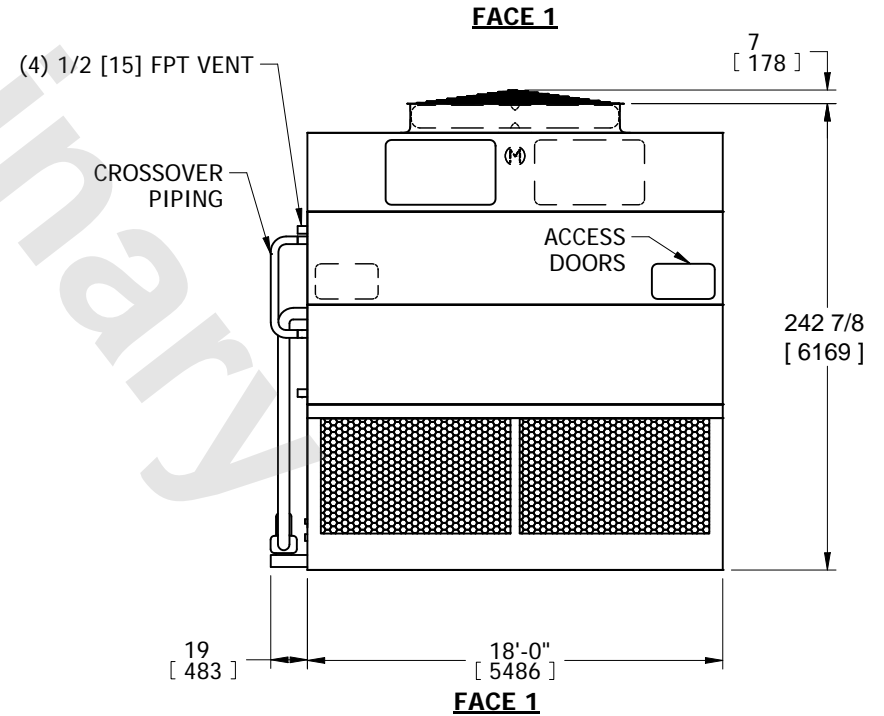
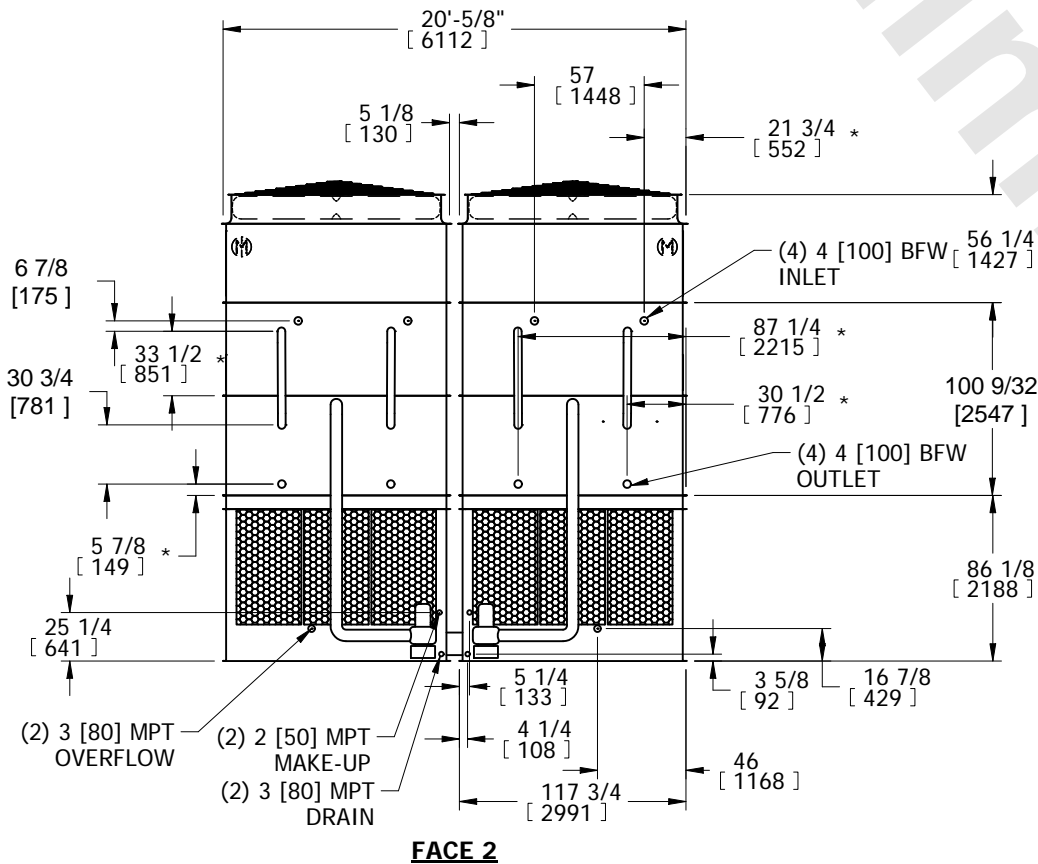

SHIPPING WEIGHT 62110 lbs+ [28175] kg+	OPERATING WEIGHT 86310 lbs+ [39150] kg+	HEAVIEST SECTION WEIGHT 24280 lbs+ [11015] kg+	NO. OF SHIPPING SECTIONS 6	DRAWN BY: SFR
---	--	---	-------------------------------	------------------