

# EVAPCO, INC.



|      |                       |         |                          |       |        |        |                  |      |   |      |           |          |  |
|------|-----------------------|---------|--------------------------|-------|--------|--------|------------------|------|---|------|-----------|----------|--|
| UNIT | CLOSED CIRCUIT COOLER | MODEL # | eco-ATWB-H 17-2K12-Z-U12 | SCALE | N.T.S. | DWG. # | EGH1712MR-DRD-SF | REV. | - | DATE | 6/21/2026 | SERIAL # |  |
|------|-----------------------|---------|--------------------------|-------|--------|--------|------------------|------|---|------|-----------|----------|--|

- NOTES:
- (M)- FAN MOTOR LOCATION
  - HEAVIEST SECTION IS COIL SECTION
  - MPT DENOTES MALE PIPE THREAD  
FPT DENOTES FEMALE PIPE THREAD  
BFW DENOTES BEVELED FOR WELDING
  - +UNIT WEIGHT DOES NOT INCLUDE ACCESSORIES (SEE ACCESSORY DRAWINGS)
  - MAKE-UP WATER PRESSURE  
20 psi MIN [137 kPa], 50 psi MAX [344 kPa]

- DIMENSIONS LISTED AS FOLLOWS:  
ENGLISH IN  
[METRIC] [mm]
- \* - APPROXIMATE DIMENSIONS DO NOT USE FOR PRE-FABRICATION OF CONNECTING PIPING.

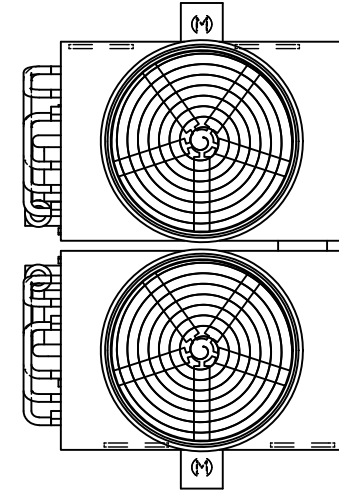

**FACE 2  
PLAN VIEW**

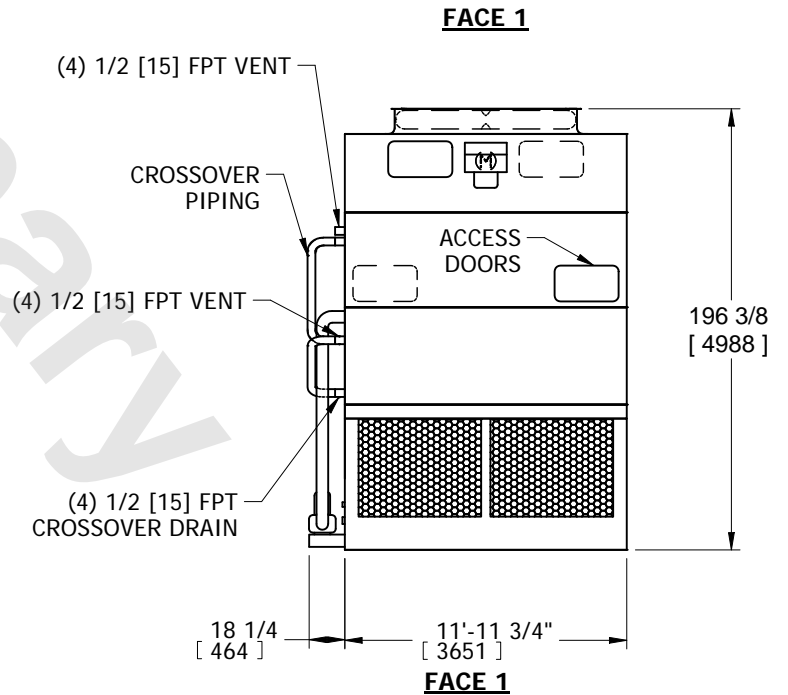
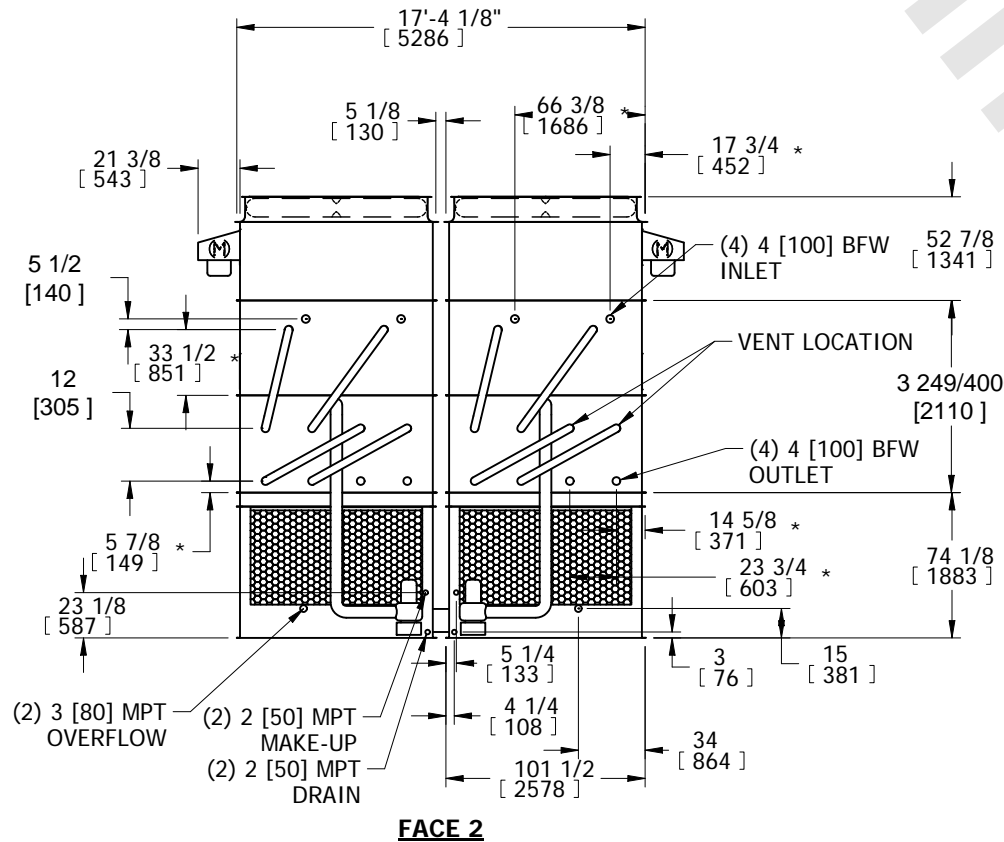

|                 |                        |                  |                        |                         |                      |                          |   |           |     |
|-----------------|------------------------|------------------|------------------------|-------------------------|----------------------|--------------------------|---|-----------|-----|
| SHIPPING WEIGHT | 24390 lbs+ [11065] kg+ | OPERATING WEIGHT | 33850 lbs+ [15355] kg+ | HEAVIEST SECTION WEIGHT | 7850 lbs+ [3560] kg+ | NO. OF SHIPPING SECTIONS | 6 | DRAWN BY: | SFR |
|-----------------|------------------------|------------------|------------------------|-------------------------|----------------------|--------------------------|---|-----------|-----|