

UNIT	COOLING TOWER	
MODEL #	SUN-112-812L	SCALE NTS

# EVAPCO, INC.

DWG. #	T3121248-DRB-SUN	REV.	-
SERIAL #		DATE	4/14/2026

- NOTES:
- (M)- FAN MOTOR LOCATION
  - HEAVIEST SECTION IS UPPER SECTION
  - MPT DENOTES MALE PIPE THREAD  
FPT DENOTES FEMALE PIPE THREAD  
BFW DENOTES BEVELED FOR WELDING  
GVD DENOTES GROOVED  
FLG DENOTES FLANGE
  - +UNIT WEIGHT DOES NOT INCLUDE ACCESSORIES (SEE ACCESSORY DRAWINGS)
  - MAKE-UP WATER PRESSURE  
20 psi MIN [137 kPa], 50 psi MAX [344 kPa]
  - 3/4" [19MM] DIA. MOUNTING HOLES. REFER TO RECOMENDED STEEL SUPPORT DRAWING.
  - DIMENSIONS LISTED AS FOLLOWS:  
ENGLISH FT-IN  
[METRIC] MM

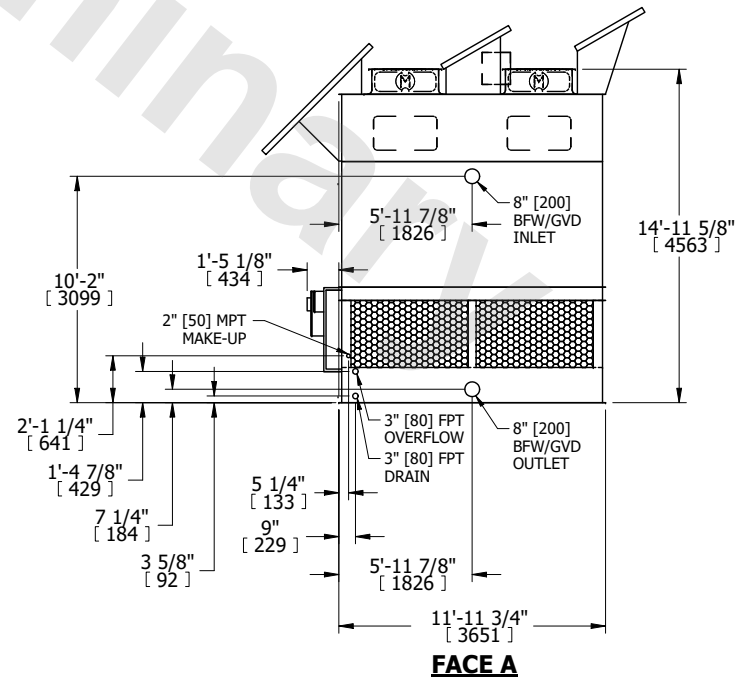
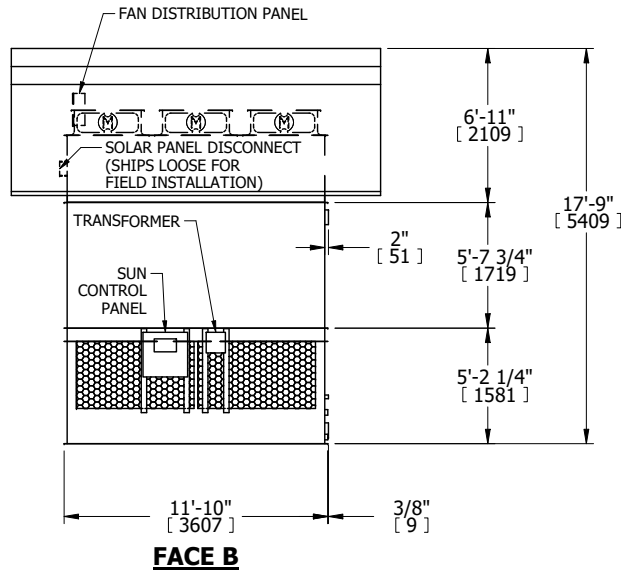
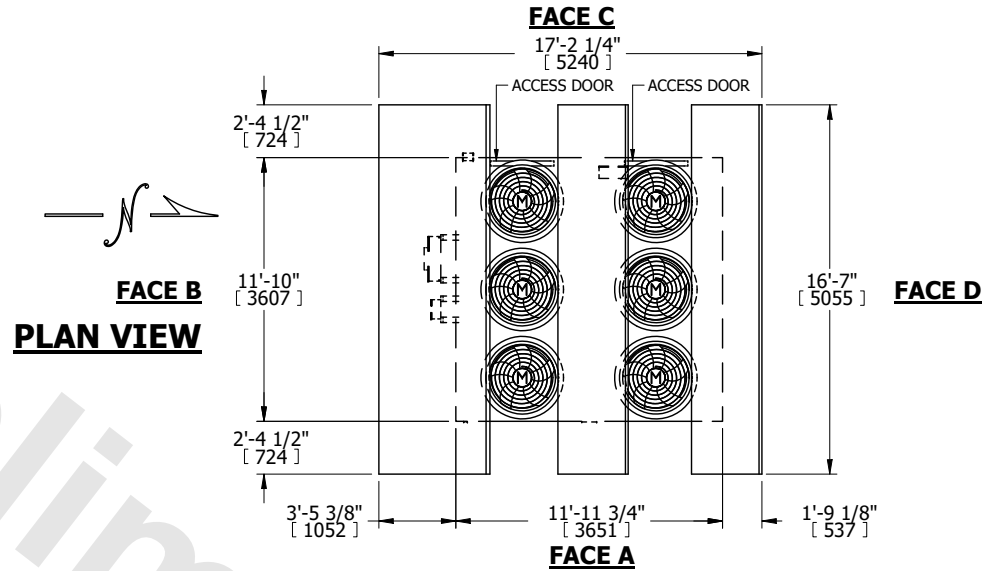

SHIPPING WEIGHT	10180 lbs+ [4620] kg+	OPERATING WEIGHT	15880 lbs+ [7205] kg+	HEAVIEST SECTION WEIGHT	3930 lbs+ [1785] kg+	NO. OF SHIPPING SECTIONS	2	DRAWN BY:	MBG
-----------------	-----------------------	------------------	-----------------------	-------------------------	----------------------	--------------------------	---	-----------	-----