

EVAPCO, INC.



UNIT COOLING TOWER	MODEL # LSTE-416	SCALE N.T.S.	DWG. # TLE040624-DRA-ST	REV. -	DATE 5/25/2026	SERIAL #
------------------------------	---------------------	-----------------	----------------------------	-----------	-------------------	----------

- NOTES:
1. (M)- FAN MOTOR LOCATION
 2. HEAVIEST SECTION IS LOWER SECTION
 3. MPT DENOTES MALE PIPE THREAD
FPT DENOTES FEMALE PIPE THREAD
BFW DENOTES BEVELED FOR WELDING
GVD DENOTES GROOVED FOR VICTAULIC
 4. +UNIT WEIGHT DOES NOT INCLUDE ACCESSORIES (SEE ACCESSORY DRAWINGS)
 5. MAKE-UP WATER PRESSURE
20 psi MIN [137 kPa], 50 psi MAX [344 kPa]
 6. 3/4" [19mm] DIA. MOUNTING HOLES. REFER TO RECOMMENDED STEEL SUPPORT DRAWING
 7. DIMENSIONS LISTED AS FOLLOWS: ENGLISH IN [METRIC] [mm]
 8. MAKE-UP CONNECTION LOCATED 7 5/8" FROM CONNECTION END OF UNIT

**FACE 1
PLAN VIEW**

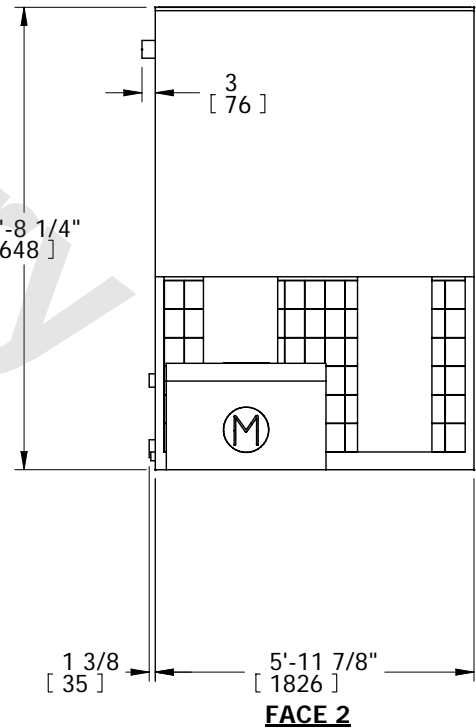
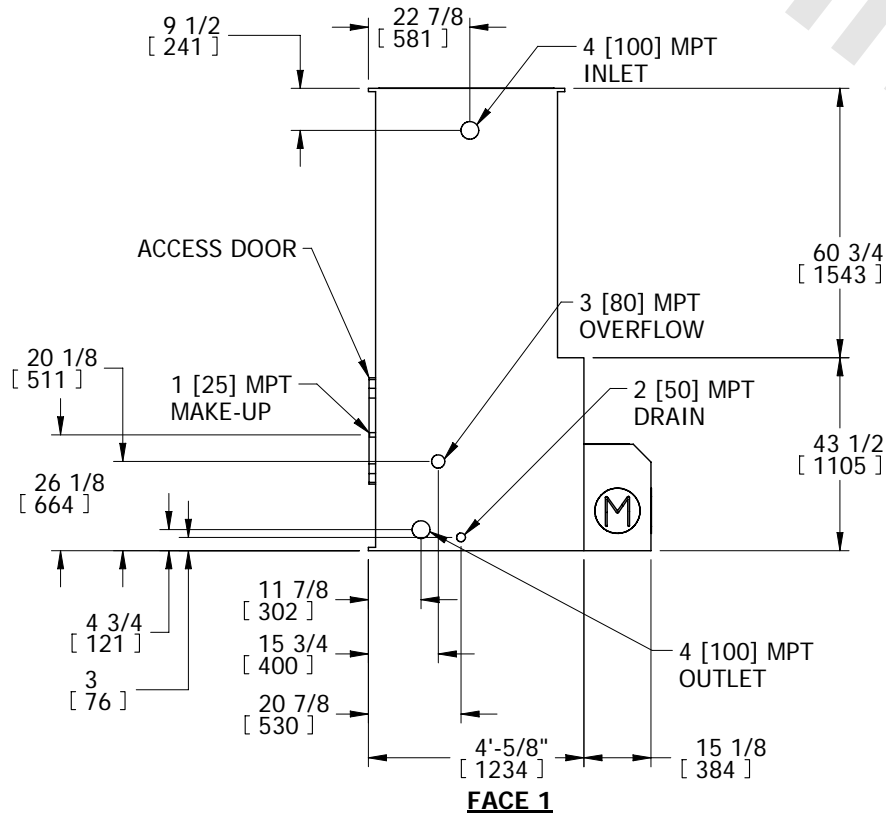
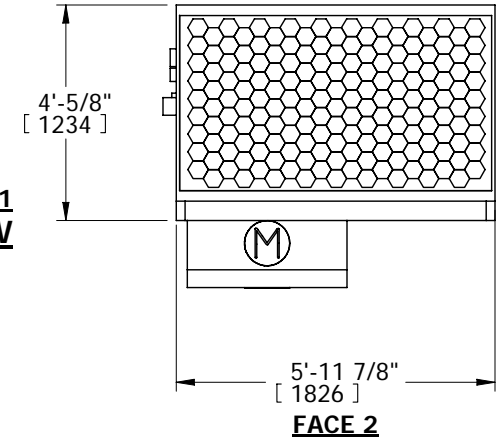

SHIPPING WEIGHT 1730 lbs+ [785] kg+	OPERATING WEIGHT 2390 lbs+ [1084] kg+	HEAVIEST SECTION WEIGHT 1080 lbs+ [490] kg+	NO. OF SHIPPING SECTIONS 2
--	--	--	-------------------------------