

# EVAPCO, INC.



UNIT <b>COOLING TOWER</b>	MODEL # LSTE-10112U	SCALE N.T.S.	DWG. # TLETM1236-DRA-ST	REV. -	DATE 5/1/2026	SERIAL #
------------------------------	------------------------	-----------------	----------------------------	-----------	------------------	----------

- NOTES:
- (M)- FAN MOTOR LOCATION
  - HEAVIEST SECTION IS LOWER SECTION
  - MPT DENOTES MALE PIPE THREAD  
FPT DENOTES FEMALE PIPE THREAD  
BFW DENOTES BEVELED FOR WELDING  
GVD DENOTES GROOVED FOR VICTAULIC
  - +UNIT WEIGHT DOES NOT INCLUDE ACCESSORIES (SEE ACCESSORY DRAWINGS)
  - MAKE-UP WATER PRESSURE  
20 psi MIN [137 kPa], 50 psi MAX [344 kPa]
  - 3/4" [19mm] DIA. MOUNTING HOLES. REFER TO RECOMMENDED STEEL SUPPORT DRAWING
  - DIMENSIONS LISTED AS FOLLOWS: ENGLISH IN [METRIC] [mm]

**FACE 1  
PLAN VIEW**

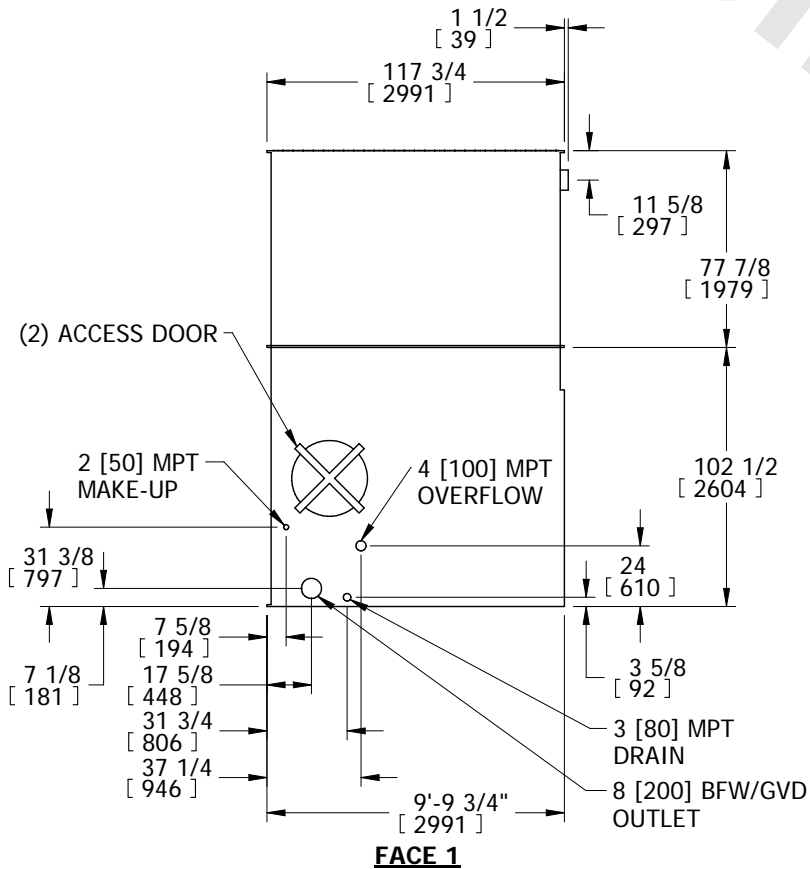
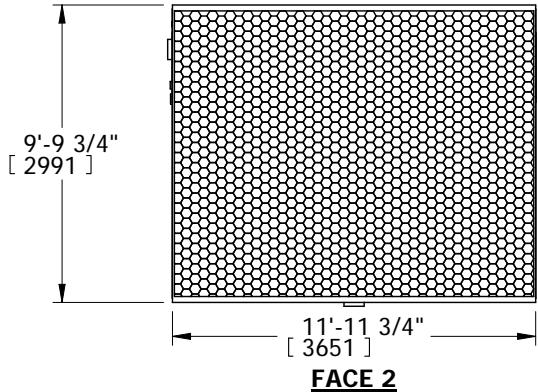

**FACE 1**

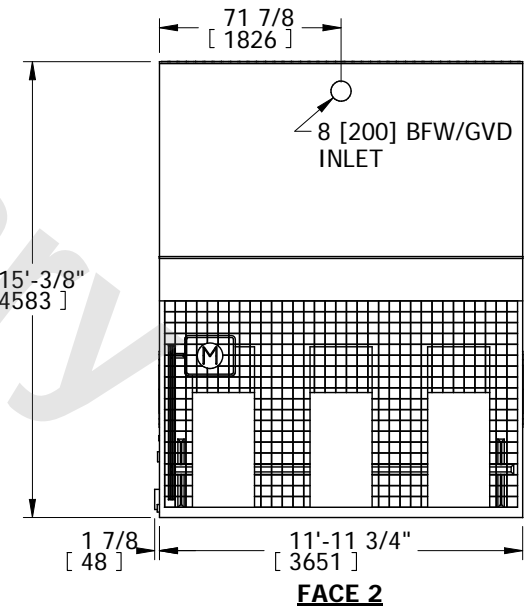

**FACE 2**

SHIPPING WEIGHT 8200 lbs+ [3719] kg+	OPERATING WEIGHT 14110 lbs+ [6400] kg+	HEAVIEST SECTION WEIGHT 5020 lbs+ [2277] kg+	NO. OF SHIPPING SECTIONS 2
---	---	---	-------------------------------