

# EVAPCO, INC.



UNIT <b>COOLING TOWER</b>	MODEL # LSTE-10224L	SCALE N.T.S.	DWG. # TLETM2436-DRA-ST	REV. -	DATE 5/24/2026	SERIAL #
------------------------------	------------------------	-----------------	----------------------------	-----------	-------------------	----------

- NOTES:
- (M)- FAN MOTOR LOCATION
  - HEAVIEST SECTION IS LOWER SECTION
  - MPT DENOTES MALE PIPE THREAD  
FPT DENOTES FEMALE PIPE THREAD  
BFW DENOTES BEVELED FOR WELDING  
GVD DENOTES GROOVED FOR VICTAULIC
  - +UNIT WEIGHT DOES NOT INCLUDE ACCESSORIES (SEE ACCESSORY DRAWINGS)
  - MAKE-UP WATER PRESSURE  
20 psi MIN [137 kPa], 50 psi MAX [344 kPa]
  - 3/4" [19mm] DIA. MOUNTING HOLES. REFER TO RECOMMENDED STEEL SUPPORT DRAWING
  - DIMENSIONS LISTED AS FOLLOWS: ENGLISH IN [METRIC] [mm]

**FACE 1  
PLAN VIEW**

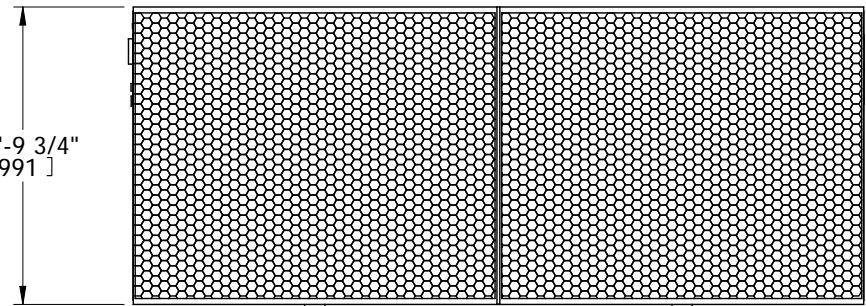

**FACE 2**

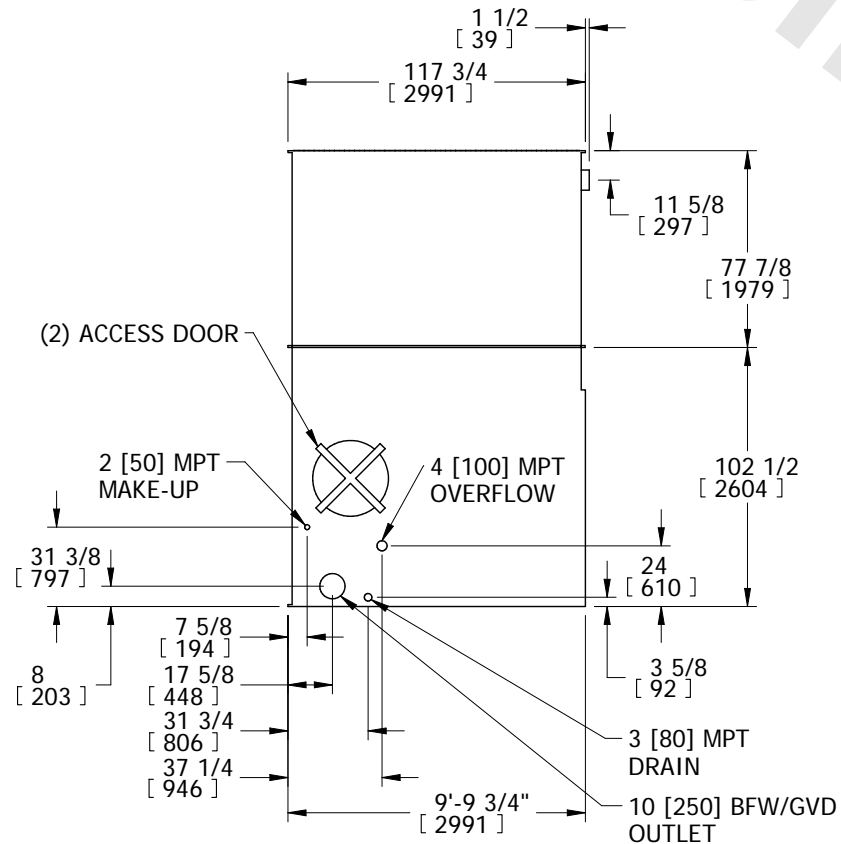

**FACE 1**

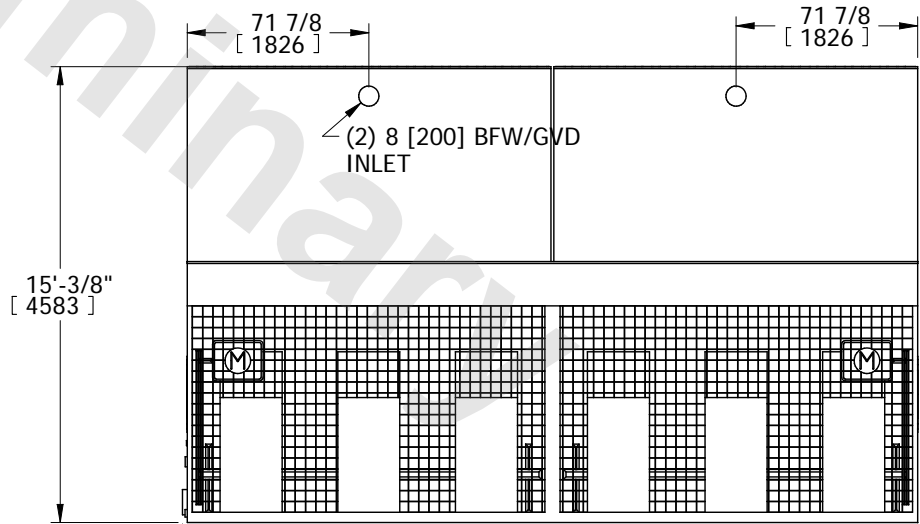

**FACE 2**

SHIPPING WEIGHT 16060 lbs+ [7285] kg+	OPERATING WEIGHT 28240 lbs+ [12809] kg+	HEAVIEST SECTION WEIGHT 9580 lbs+ [4345] kg+	NO. OF SHIPPING SECTIONS 3
--	--	---	-------------------------------