

CONFIDENTIAL

This document is the property of Evapco, Inc. It should not be copied or disclosed without prior written authorization.

EVAPCO, INC.



| | | | | | |
|----------|-----------------------------|--------------|--------------------|--------|----------------|
| CUSTOMER | MODEL # SSTMB1-764H0075C2LA | SCALE N.T.S. | DWG. # STMC1-SE-12 | REV. 0 | DATE 4/24/2026 |
|----------|-----------------------------|--------------|--------------------|--------|----------------|

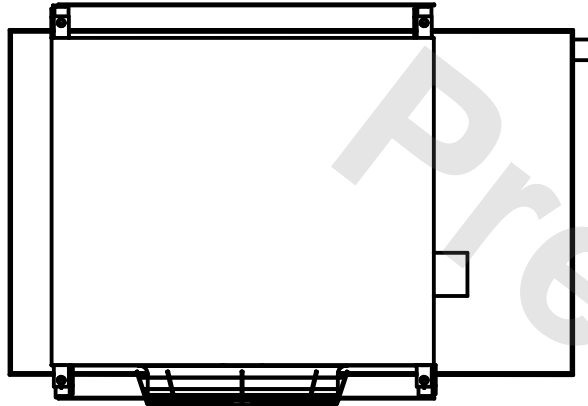

NOTES:

- 1) * = HANGER HOLE LOCATION.
- 2) RIGHT HAND MODEL SHOWN.
- 3) HANGER HOLES ARE FOR 3/4 INCH THREADED ROD.
- 4) WATER DEFROST ADDS 1 3/4" INCHES TO HEIGHT OF STANDARD UNIT AND CHANGES DRAIN SIZE.
- 5) ALL DIMENSIONS ARE FOR REFERENCE AND SHOULD NOT BE USED FOR PREFABRICATION OF PIPING OR SUPPORTS.

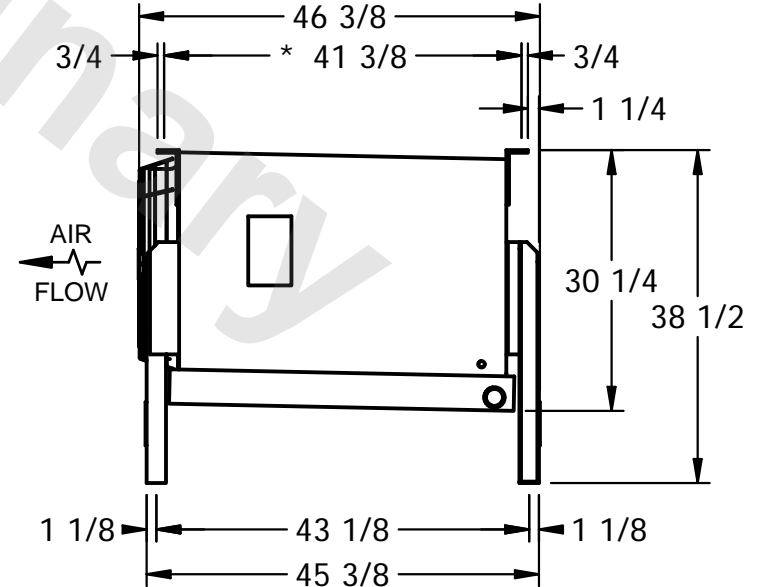
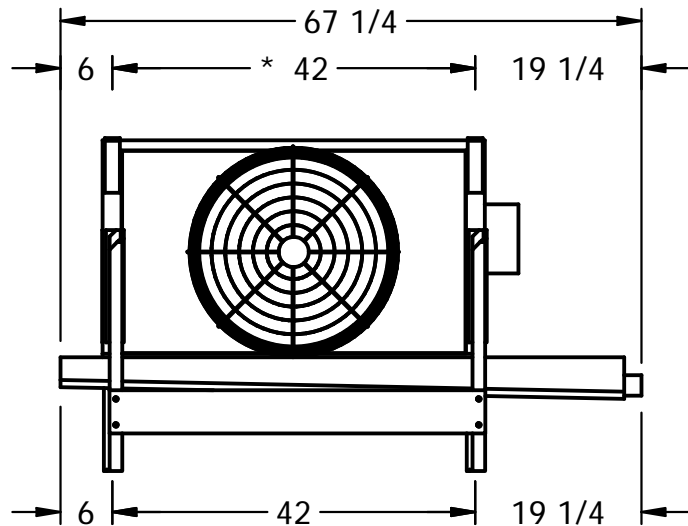

| | | | |
|---------|------|-------------------------|--------------------------|
| PROJECT | ROOM | SHIPPING WEIGHT 530 lbs | OPERATING WEIGHT 580 lbs |
|---------|------|-------------------------|--------------------------|