

CONFIDENTIAL
This document is the property of Evapco, Inc. It should not be copied or disclosed without prior written authorization.

EVAPCO, INC.

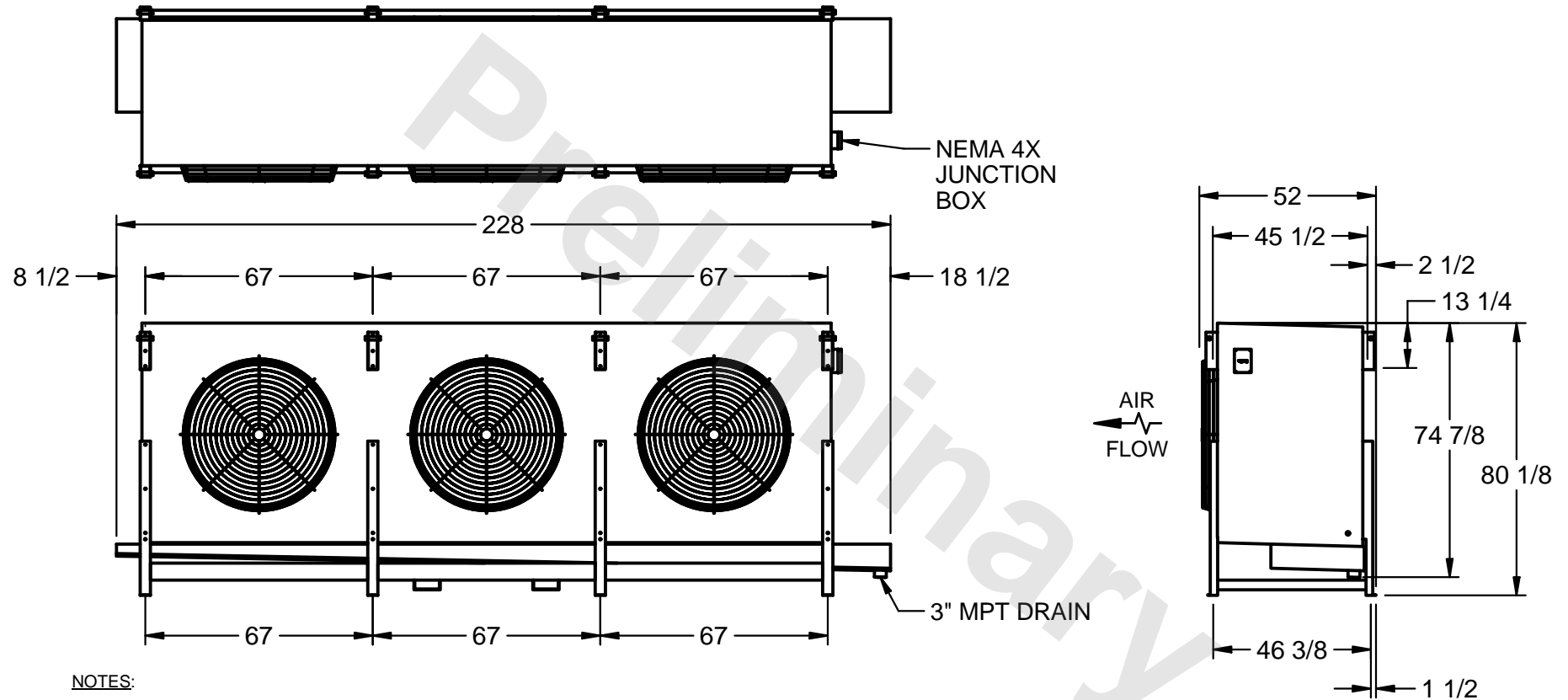

CUSTOMER MODEL # SSTLB3-8410VF0300K4KA SCALE N.T.S. DWG. # STL3-SE-20-10R-FL REV. 1 DATE 5/19/2026



NOTES:

- 1) RIGHT HAND MODEL SHOWN.
- 2) ALL DIMENSIONS ARE FOR REFERENCE AND SHOULD NOT BE USED FOR PREFABRICATION OF PIPING OR SUPPORTS.
- 3) WATER DEFROST ADDS 6 INCHES TO HEIGHT OF STANDARD UNIT AND CHANGES DRAIN SIZE.
- 4) HANGER HOLES ARE FOR 3/4 INCH THREADED ROD.

PROJECT ROOM SHIPPING WEIGHT 5070 lbs OPERATING WEIGHT 6110 lbs