

CONFIDENTIAL

This document is the property of Evapco, Inc. It should not be copied or disclosed without prior written authorization.

EVAPCO, INC.



CUSTOMER

MODEL # SSTLB4-1238WF0150K1KA

SCALE N.T.S.

DWG. # STL4-SE-22-FL

REV. 1

DATE 5/16/2026

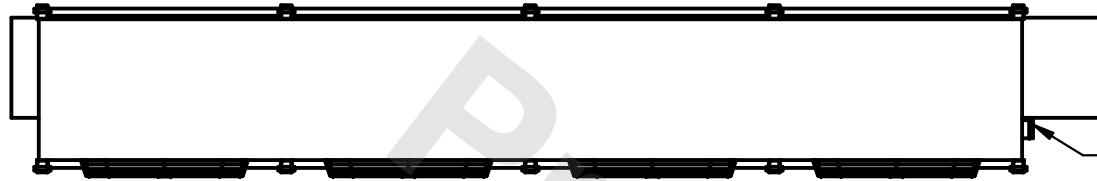

NEMA 4X JUNCTION BOX

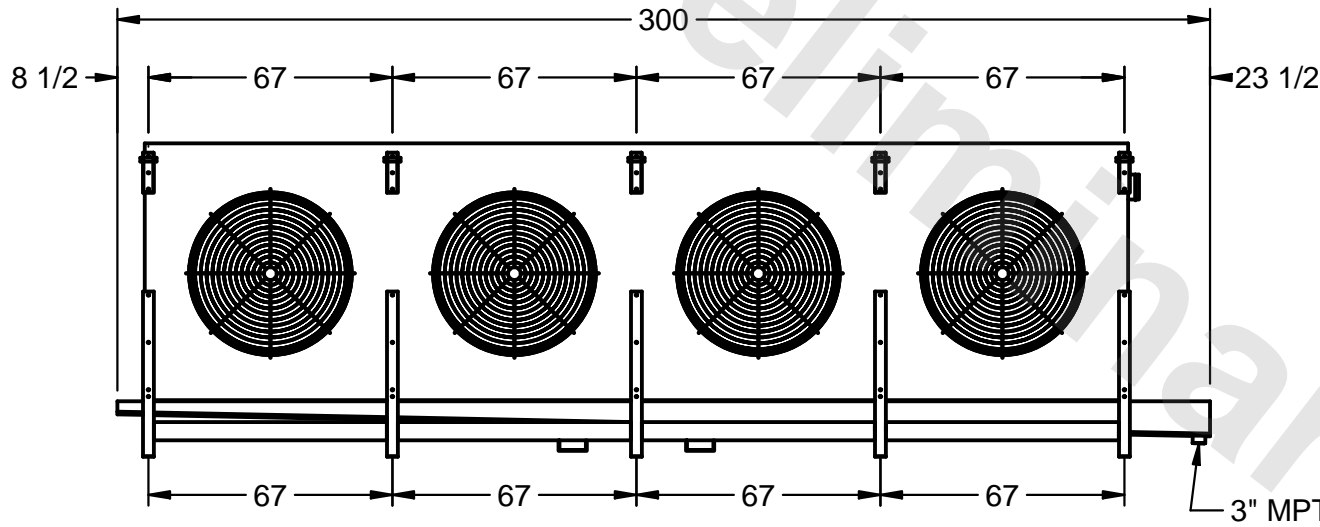

AIR FLOW

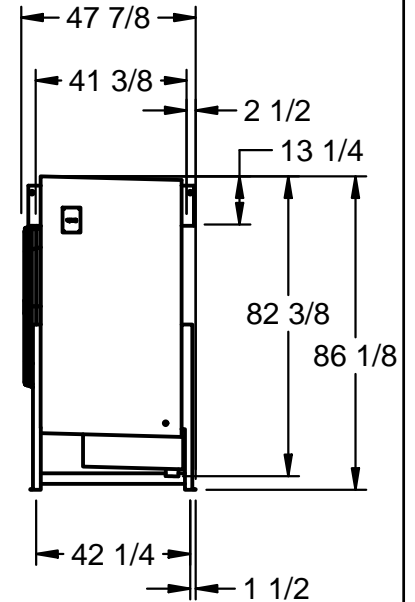

NOTES:

- 1) RIGHT HAND MODEL SHOWN.
- 2) ALL DIMENSIONS ARE FOR REFERENCE AND SHOULD NOT BE USED FOR PREFABRICATION OF PIPING OR SUPPORTS.
- 3) WATER DEFROST ADDS 6 INCHES TO HEIGHT OF STANDARD UNIT AND CHANGES DRAIN SIZE.
- 4) HANGER HOLES ARE FOR 3/4 INCH THREADED ROD.

PROJECT

ROOM

SHIPPING WEIGHT 6950 lbs

OPERATING WEIGHT 8340 lbs