

CONFIDENTIAL

This document is the property of Evapco, Inc. It should not be copied or disclosed without prior written authorization.

EVAPCO, INC.



CUSTOMER	MODEL # SSTWB1-9R63F0100F1KA	SCALE N.T.S.	DWG.# STWA1-SE-6L	REV. 0	DATE 4/24/2026
----------	------------------------------	--------------	-------------------	--------	----------------

NEMA 4X
JUNCTION
BOX

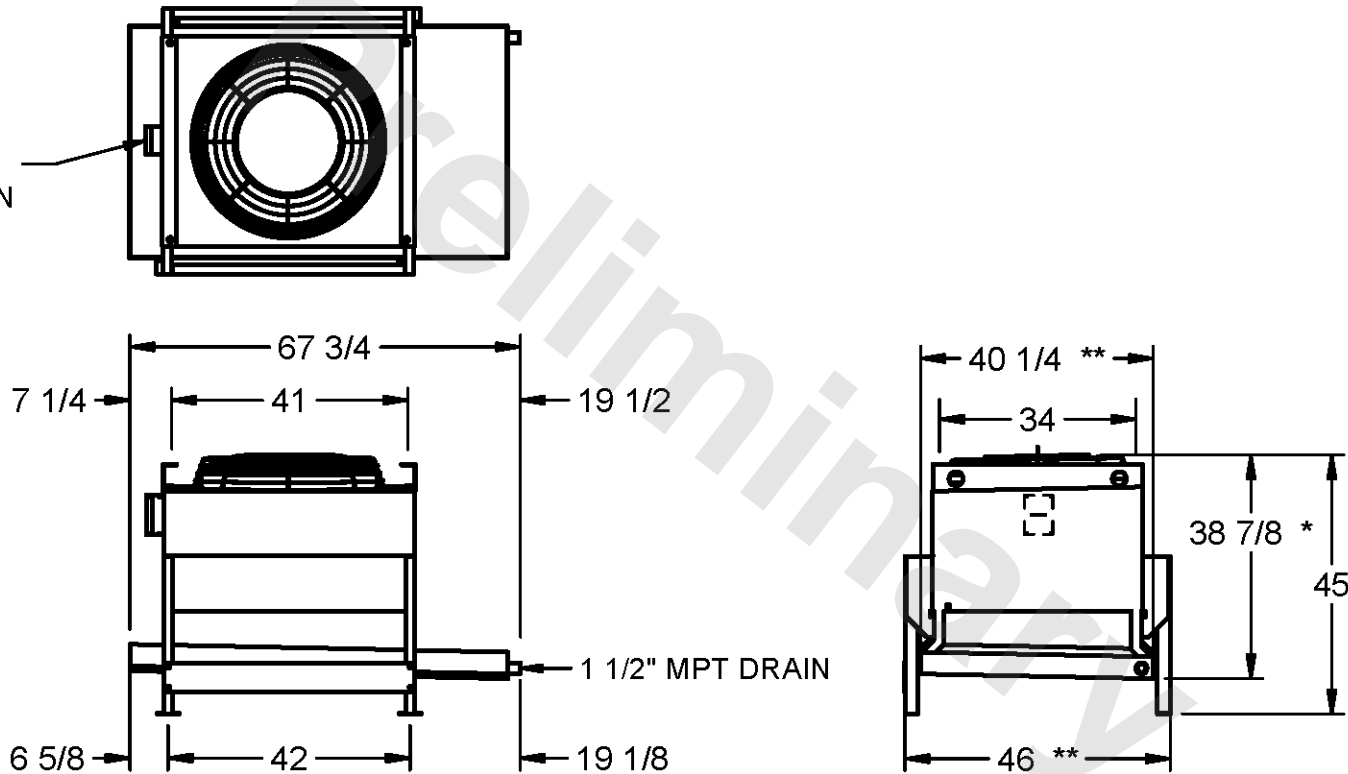

NOTES

- 1) ALL DIMENSIONS ARE FOR REFERENCE AND SHOULD NOT BE USED FOR PREFABRICATION OF PIPING OR SUPPORTS.
- 2) HANGER HOLES ARE FOR 3/4 INCH THREADED ROD.
- * HOT GAS DEFROST ADDS 1/2 INCH TO THE HEIGHT OF A STANDARD UNIT, WATER DEFROST ADDS 6 INCHES TO THE HEIGHT OF A STANDARD UNIT AND CHANGES THE DRAIN SIZE.
- ** EXTENDED WIDTH DRAIN PAN ADDS 6 INCHES TO THE WIDTH OF A STANDARD UNIT.

PROJECT	ROOM	SHIPPING WEIGHT 560 lbs+ [255] kg+	OPERATING WEIGHT 610 lbs+ [280] kg+
---------	------	------------------------------------	-------------------------------------