

CONFIDENTIAL  
This document is the property of Evapco, Inc. It should not be copied or disclosed without prior written authorization.

EVAPCO, INC.

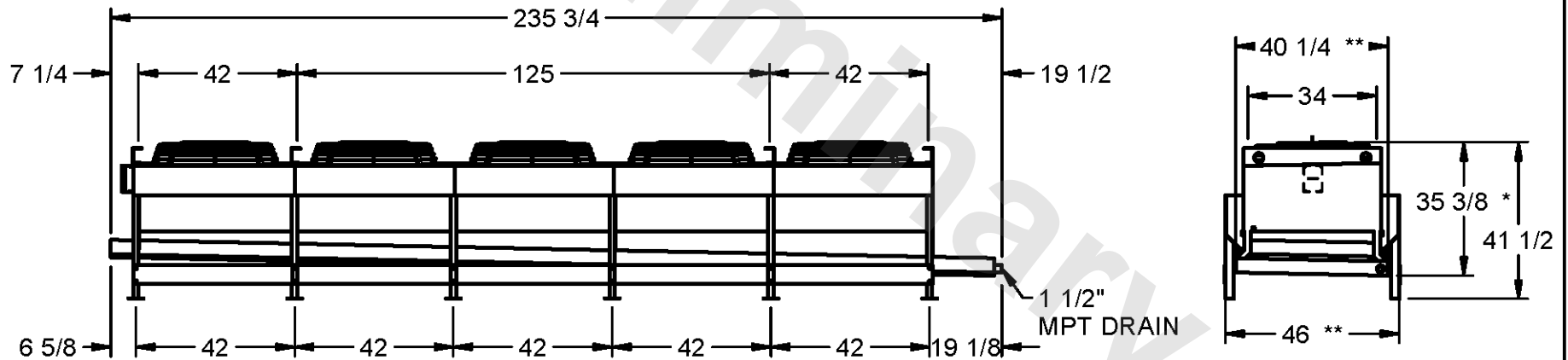

CUSTOMER \_\_\_\_\_ MODEL # SSTWB5-47S44F0150F1LA SCALE N.T.S. DWG.# STWA5-SE-4L REV. 0 DATE 6/25/2026



**NOTES**

- 1) ALL DIMENSIONS ARE FOR REFERENCE AND SHOULD NOT BE USED FOR PREFABRICATION OF PIPING OR SUPPORTS.
- 2) HANGER HOLES ARE FOR 3/4 INCH THREADED ROD.
- \* HOT GAS DEFROST ADDS 1/2 INCH TO THE HEIGHT OF A STANDARD UNIT, WATER DEFROST ADDS 6 INCHES TO THE HEIGHT OF A STANDARD UNIT AND CHANGES THE DRAIN SIZE.
- \*\* EXTENDED WIDTH DRAIN PAN ADDS 6 INCHES TO THE WIDTH OF A STANDARD UNIT.

PROJECT \_\_\_\_\_ ROOM \_\_\_\_\_ SHIPPING WEIGHT 1970 lbs+ [895] kg+ OPERATING WEIGHT 2190 lbs+ [995] kg+