

CONFIDENTIAL
This document is the property of Evapco, Inc. It should not be copied or disclosed without prior written authorization.

EVAPCO, INC.



CUSTOMER MODEL # SSTWB1-9S86H0100F1KA SCALE N.T.S. DWG.# STWA1-SE REV. 0 DATE 6/25/2026

NEMA 4X
JUNCTION
BOX

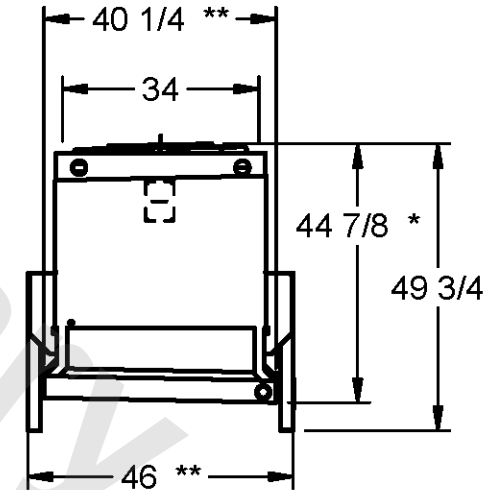
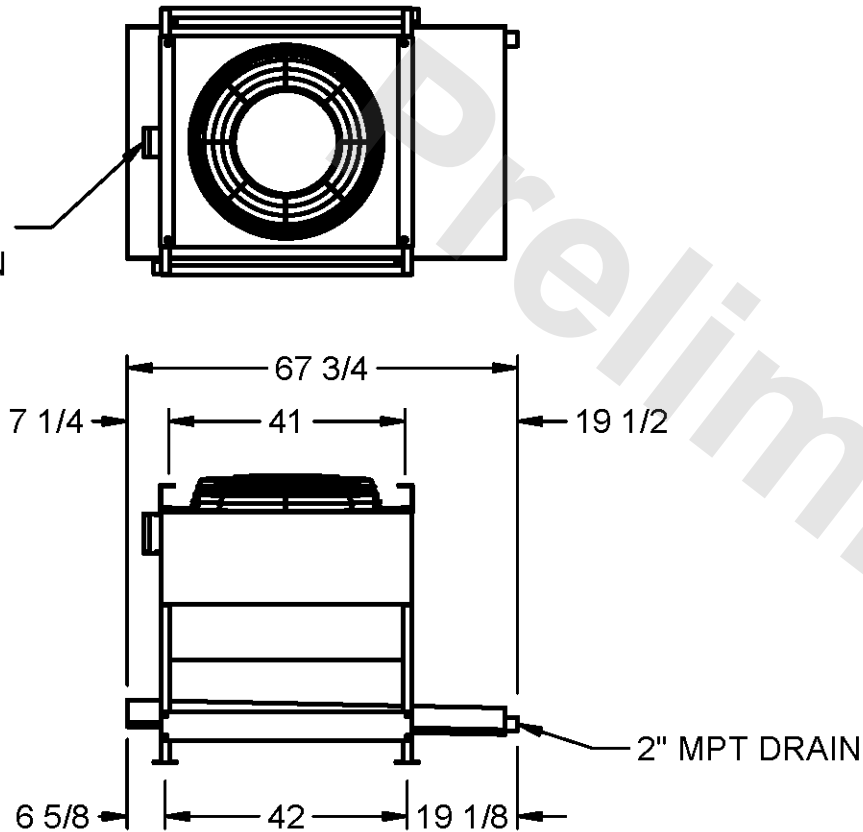

NOTES

- 1) ALL DIMENSIONS ARE FOR REFERENCE AND SHOULD NOT BE USED FOR PREFABRICATION OF PIPING OR SUPPORTS.
- 2) HANGER HOLES ARE FOR 3/4 INCH THREADED ROD.
- * HOT GAS DEFROST ADDS 1/2 INCH TO THE HEIGHT OF A STANDARD UNIT, WATER DEFROST ADDS 6 INCHES TO THE HEIGHT OF A STANDARD UNIT AND CHANGES THE DRAIN SIZE
- * TWO ROWS REHEAT ADDS 5.25 INCHES TO THE HEIGHT OF 6 AND 8 ROW DEEEP STANDARD UNITS.
- * FOUR ROWS REHEAT ADDS 5.25 INCHES TO THE HEIGHT OF 4 AND 6 ROW DEEP STANDARD UNITS AND 8.75 INCHES TO THE HEIGHT OF 8 ROW DEEP STANDARD UNITS.
- ** EXTENDED WIDTH DRAIN PAN ADDS 6 INCHES TO THE WIDTH OF A STANDARD UNIT.

PROJECT ROOM SHIPPING WEIGHT 790 lbs+ [360] kg+ OPERATING WEIGHT 900 lbs+ [410] kg+