

EVAPCO, INC.



UNIT CONDENSER	MODEL # eco-ATC-1401A	SCALE N.T.S.	DWG. # EG241808-DRA-ST	REV. -	DATE 4/5/2026	SERIAL #
--------------------------	--------------------------	-----------------	---------------------------	-----------	------------------	----------

- NOTES:
- (M)- FAN MOTOR LOCATION
 - HEAVIEST SECTION IS UPPER SECTION
 - MPT DENOTES MALE PIPE THREAD
FPT DENOTES FEMALE PIPE THREAD
BFW DENOTES BEVELED FOR WELDING
 - +UNIT WEIGHT DOES NOT INCLUDE ACCESSORIES (SEE ACCESSORY DRAWINGS)
 - MAKE-UP WATER PRESSURE
20 psi MIN [137 kPa], 50 psi MAX [344 kPa]
 - * -APPROXIMATE DIMENSIONS DO NOT USE FOR PRE-FABRICATION OF CONNECTING PIPING
 - VENT PROVIDED ON CLOSED CIRCUIT COOLERS ONLY

Preliminary

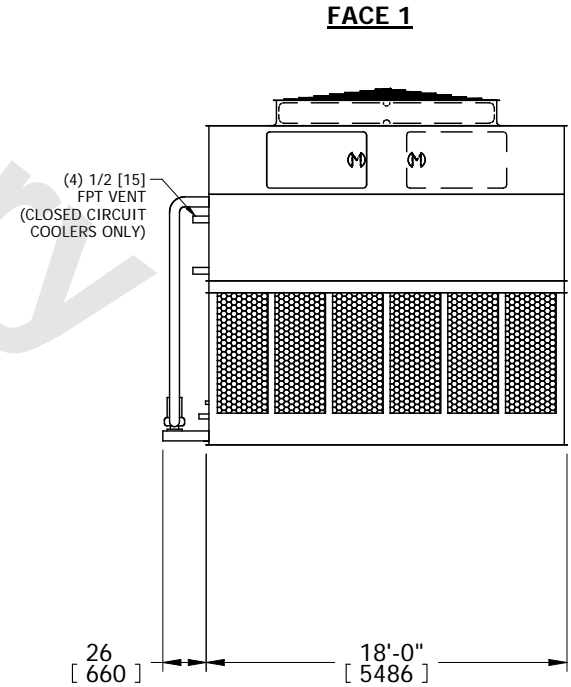
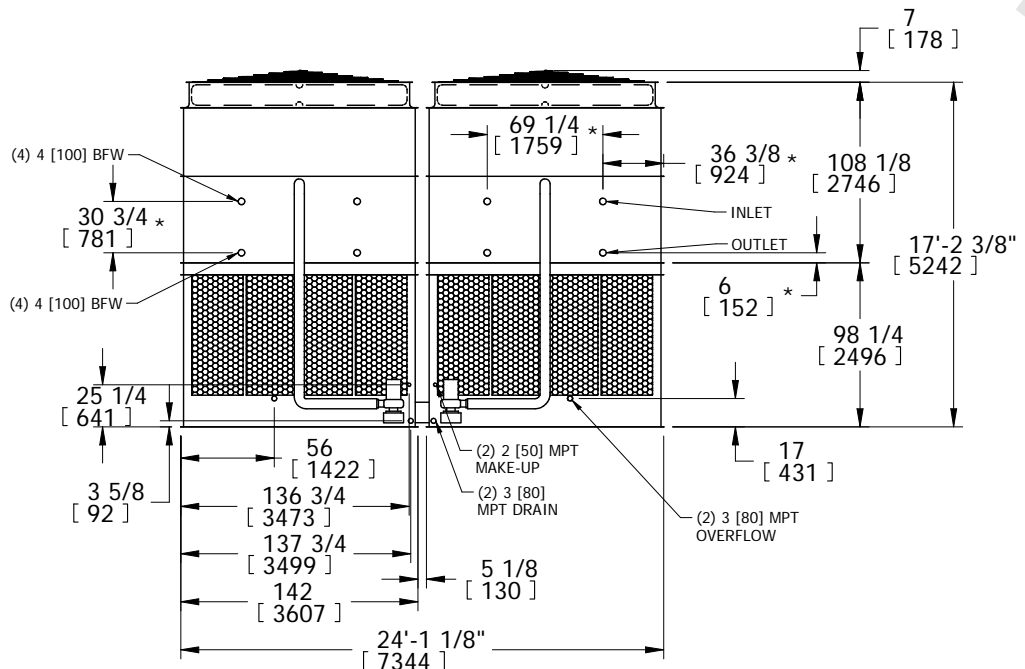

SHIPPING WEIGHT 58120 lbs+ [26365] kg+	OPERATING WEIGHT 78600 lbs+ [35655] kg+	HEAVIEST SECTION WEIGHT 25140 lbs+ [11405] kg+	NO. OF SHIPPING SECTIONS 4
--	---	--	--------------------------------------