

UNIT	<b>CONDENSER</b>	
MODEL #	eco-ATC-495A	SCALE NTS

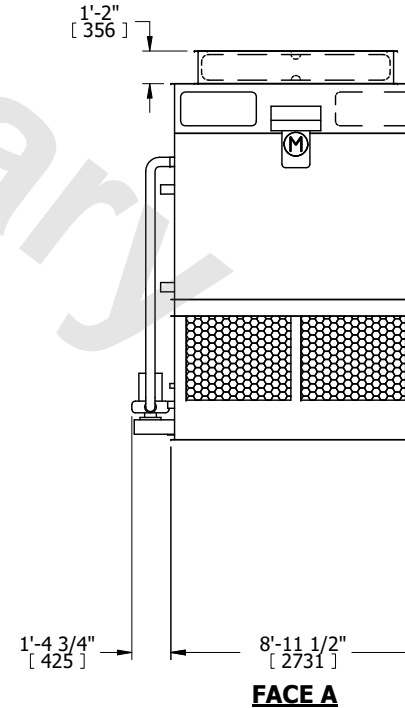

DWG. #	CW4C140912-DRA-ST	REV.	-
SERIAL #		DATE	4/11/2026

- NOTES:
- (M)- FAN MOTOR LOCATION
  - HEAVIEST SECTION IS FAN/CASING SECTION
  - MPT DENOTES MALE PIPE THREAD  
FPT DENOTES FEMALE PIPE THREAD  
BFW DENOTES BEVELED FOR WELDING  
GVD DENOTES GROOVED  
FLG DENOTES FLANGE  
PE DENOTES PLAIN END
  - +UNIT WEIGHT DOES NOT INCLUDE ACCESSORIES (SEE ACCESSORY DRAWINGS)
  - MAKE-UP WATER PRESSURE  
20 psi MIN [137 kPa], 50 psi MAX [344 kPa]
  - \*-APPROXIMATE DIMENSIONS DO NOT USE FOR PRE-FABRICATION OF CONNECTING PIPING
  - 3/4" [19mm] DIA. MOUNTING HOLES. REFER TO RECOMMENDED STEEL SUPPORT DRAWING.
  - DIMENSIONS LISTED AS FOLLOWS:  
ENGLISH FT-IN  
METRIC [mm]

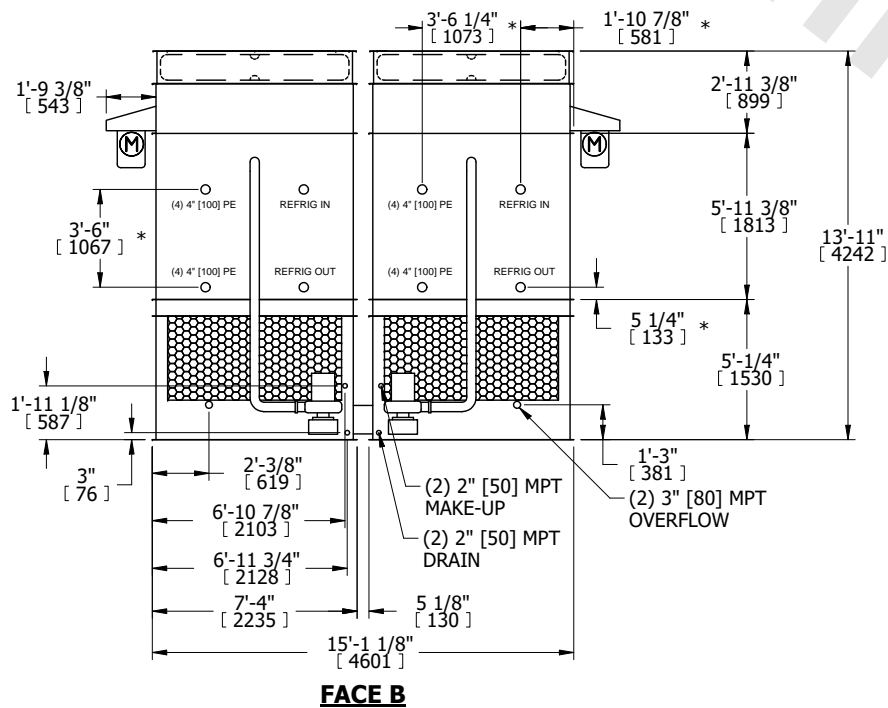
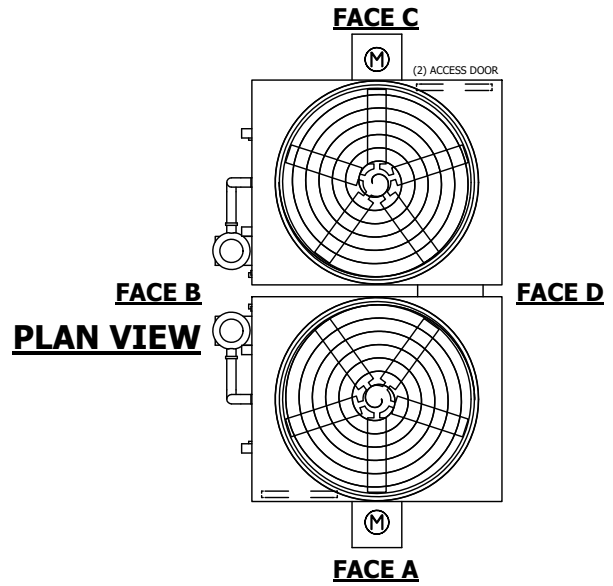

SHIPPING WEIGHT	34260 lbs+ [15545] kg+	OPERATING WEIGHT	36080 lbs+ [16370] kg+	HEAVIEST SECTION WEIGHT	14080 lbs+ [6390] kg+	NO. OF SHIPPING SECTIONS	4	DRAWN BY:	TAM
-----------------	------------------------	------------------	------------------------	-------------------------	-----------------------	--------------------------	---	-----------	-----