

UNIT	CONDENSER	
MODEL #	eco-ATC-791A	SCALE NTS

# EVAPCO, INC.

DWG. #	CW4C141410-DRB-ST	REV	-
SERIAL #		DATE:	4/6/2026

### NOTES

- (M)- FAN MOTOR LOCATION
- HEAVIEST SECTION IS FAN/CASING SECTION
- MPT DENOTES MALE PIPE THREAD  
FPT DENOTES FEMALE PIPE THREAD  
BFW DENOTES BEVELED FOR WELDING  
GVD DENOTES GROOVED  
FLG DENOTES FLANGE  
PE DENOTES PLAIN END
- +UNIT WEIGHT DOES NOT INCLUDE ACCESSORIES (SEE ACCESSORY DRAWINGS)
- MAKE-UP WATER PRESSURE  
20 psi MIN [137 kPa], 50 psi MAX [344 kPa]
- \*-APPROXIMATE DIMENSIONS DO NOT USE FOR PRE-FABRICATION OF CONNECTING PIPING
- 3/4" [19mm] DIA. MOUNTING HOLES. REFER TO RECOMMENDED STEEL SUPPORT DRAWING.
- DIMENSIONS LISTED AS FOLLOWS:  
ENGLISH FT-IN  
METRIC [mm]

Preliminary

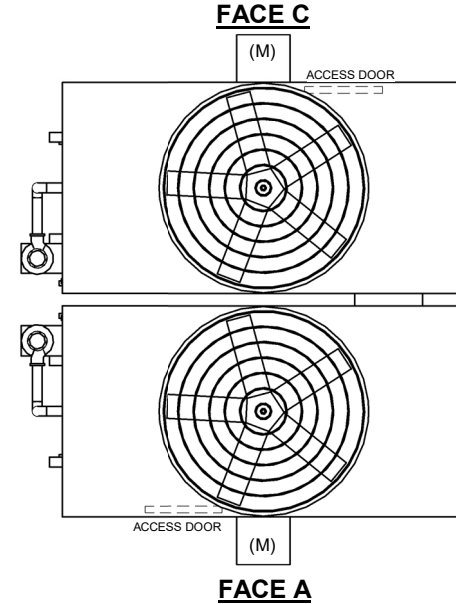

**FACE B  
PLAN VIEW**

**FACE D**

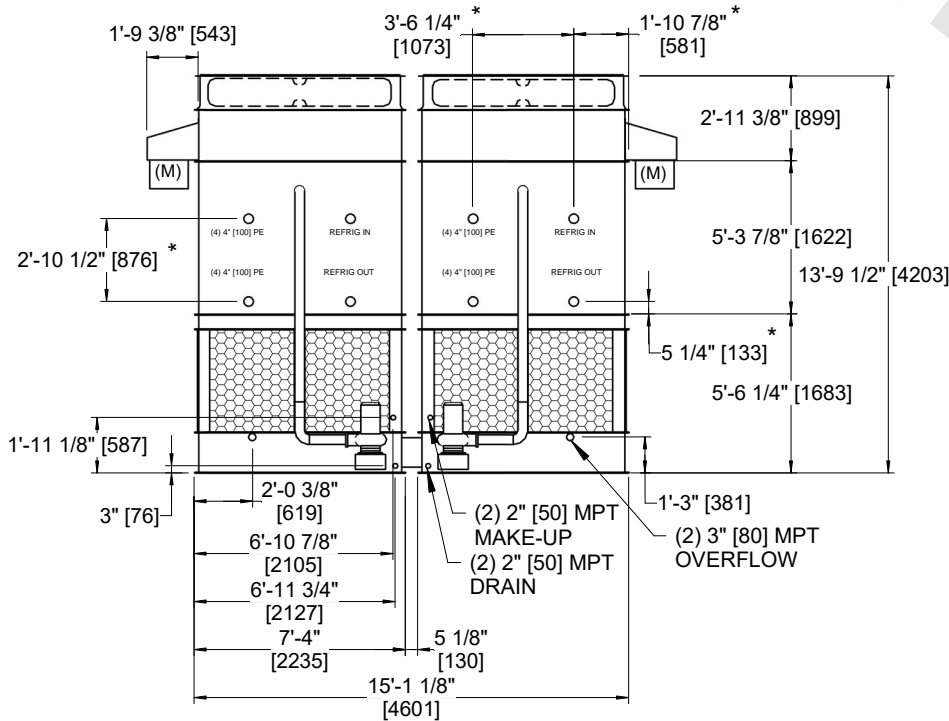

**FACE B**

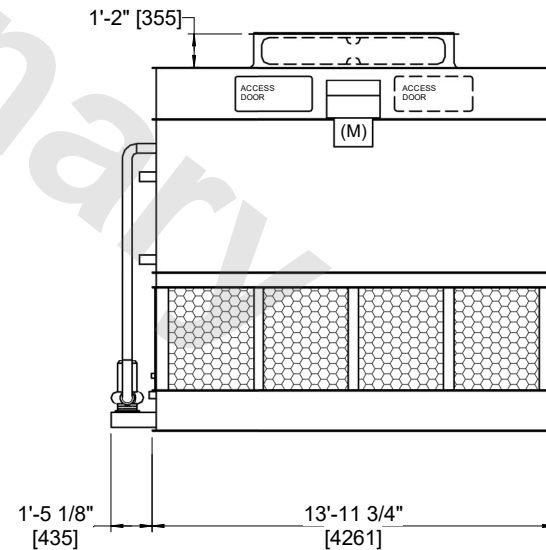

**FACE A**

SHIPPING WEIGHT	34120 lbs+ [15480] kg+	OPERATING WEIGHT	36000 lbs+ [16330] kg+	HEAVIEST SECTION WEIGHT	14870 lbs+ [6745] kg+	NO. OF SHIPPING SECTIONS	4	DRAWN BY:	JLG
-----------------	------------------------	------------------	------------------------	-------------------------	-----------------------	--------------------------	---	-----------	-----