

CONFIDENTIAL

This document is the property of Evapco, Inc. It should not be copied or disclosed without prior written authorization.

EVAPCO, INC.



CUSTOMER	MODEL # SSTHB3-6764F0500K1LA	SCALE N.T.S.	DWG. # STL3-SE-16-FL	REV. 1	DATE 7/2/2026
----------	---------------------------------	-----------------	-------------------------	--------	------------------



NEMA 4X JUNCTION BOX



3" MPT DRAIN

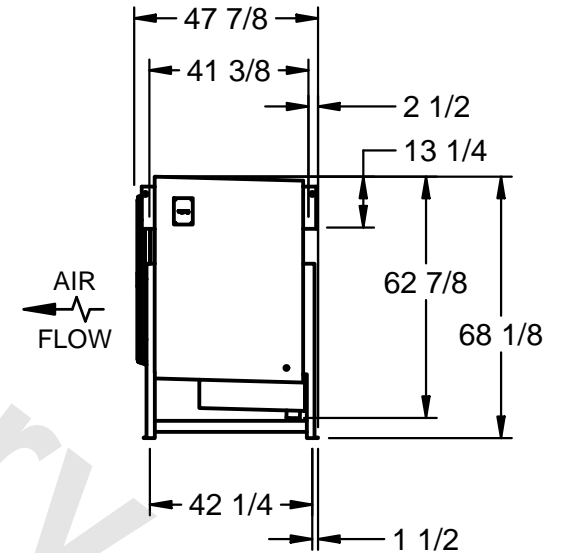

AIR FLOW

NOTES:

- 1) RIGHT HAND MODEL SHOWN.
- 2) ALL DIMENSIONS ARE FOR REFERENCE AND SHOULD NOT BE USED FOR PREFABRICATION OF PIPING OR SUPPORTS.
- 3) WATER DEFROST ADDS 6 INCHES TO HEIGHT OF STANDARD UNIT AND CHANGES DRAIN SIZE.
- 4) HANGER HOLES ARE FOR 3/4 INCH THREADED ROD.

PROJECT	ROOM	SHIPPING WEIGHT 3360 lbs	OPERATING WEIGHT 3840 lbs
---------	------	--------------------------	---------------------------