

CONFIDENTIAL

This document is the property of Evapco, Inc. It should not be copied or disclosed without prior written authorization.

# EVAPCO, INC.



|          |                                 |                 |                         |        |                  |
|----------|---------------------------------|-----------------|-------------------------|--------|------------------|
| CUSTOMER | MODEL #<br>SSTHB1-2583H0300L1KA | SCALE<br>N.T.S. | DWG. #<br>STL1-SE-18-FL | REV. 1 | DATE<br>8/6/2025 |
|----------|---------------------------------|-----------------|-------------------------|--------|------------------|

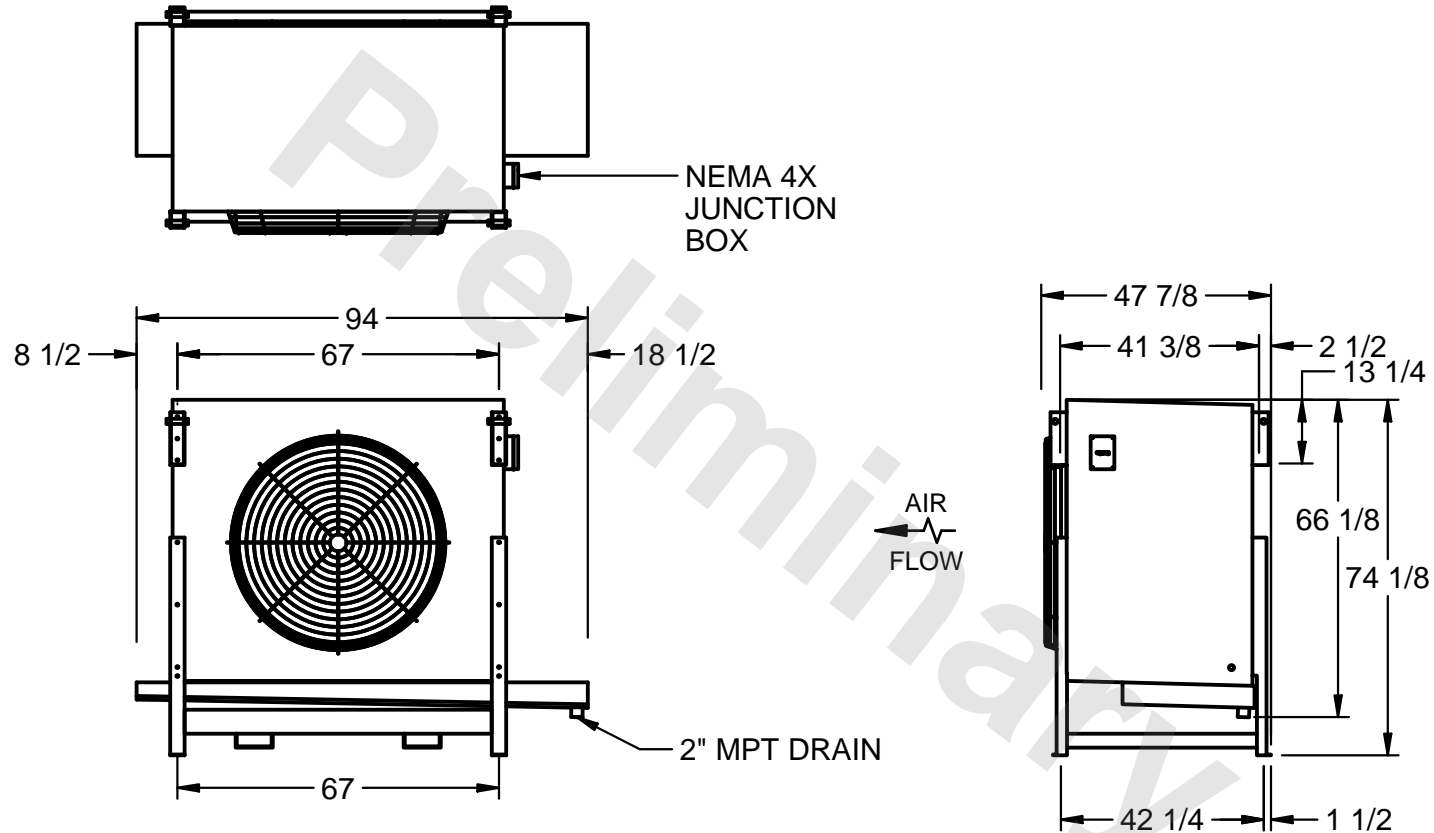

**NOTES:**

- 1) RIGHT HAND MODEL SHOWN.
- 2) ALL DIMENSIONS ARE FOR REFERENCE AND SHOULD NOT BE USED FOR PREFABRICATION OF PIPING OR SUPPORTS.
- 3) WATER DEFROST ADDS 6 INCHES TO HEIGHT OF STANDARD UNIT AND CHANGES DRAIN SIZE.
- 4) HANGER HOLES ARE FOR 3/4 INCH THREADED ROD.

|         |      |                          |                           |
|---------|------|--------------------------|---------------------------|
| PROJECT | ROOM | SHIPPING WEIGHT 1780 lbs | OPERATING WEIGHT 1980 lbs |
|---------|------|--------------------------|---------------------------|