

CONFIDENTIAL

This document is the property of Evapco, Inc. It should not be copied or disclosed without prior written authorization.

EVAPCO, INC.



CUSTOMER	MODEL # SSTHB2-506VE0150K1KA	SCALE N.T.S.	DWG. # STL2-SE-18-FL	REV. 1	DATE 5/3/2026
----------	---------------------------------	-----------------	-------------------------	--------	------------------

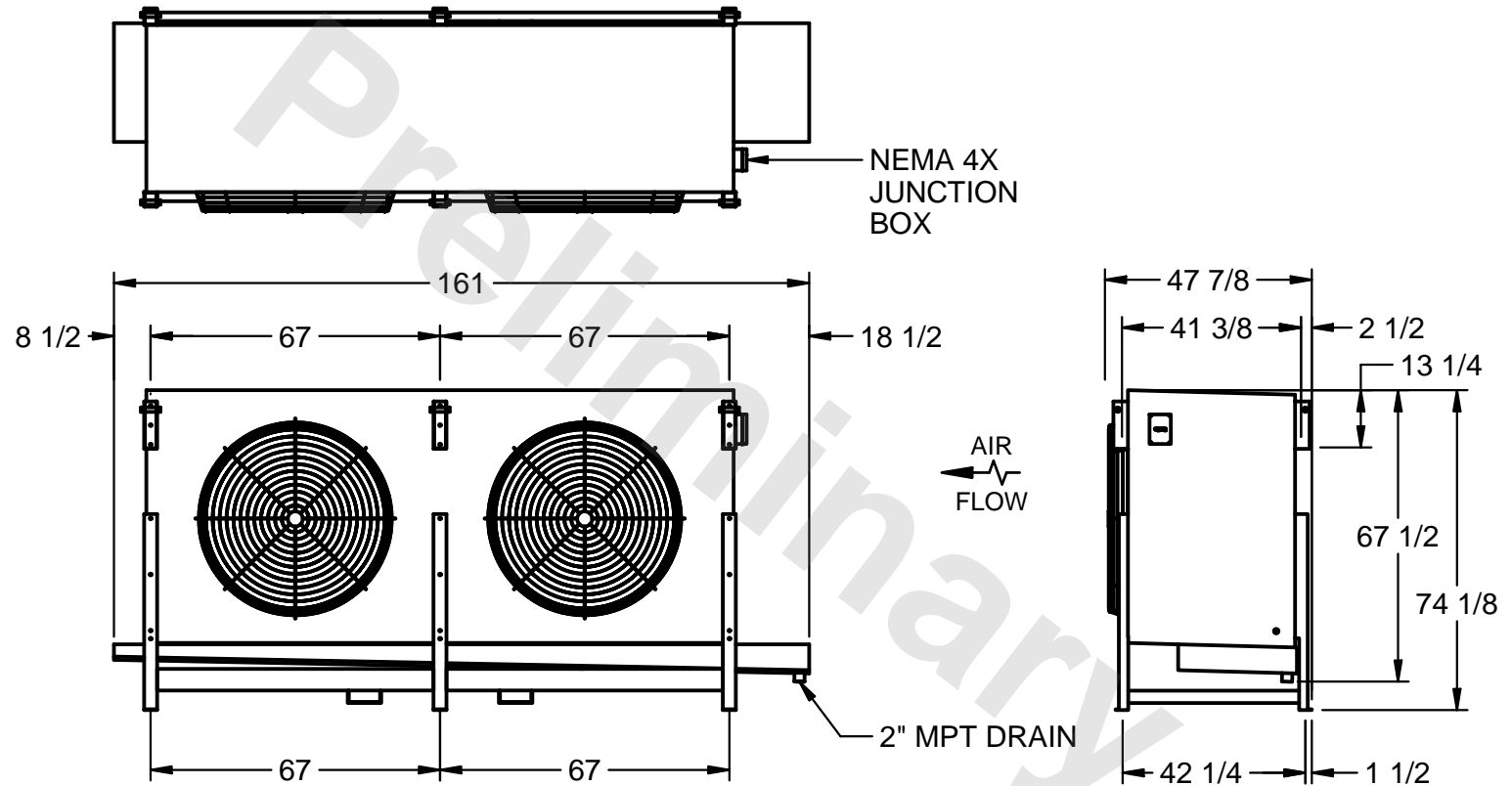

NOTES:

- 1) RIGHT HAND MODEL SHOWN.
- 2) ALL DIMENSIONS ARE FOR REFERENCE AND SHOULD NOT BE USED FOR PREFABRICATION OF PIPING OR SUPPORTS.
- 3) WATER DEFROST ADDS 6 INCHES TO HEIGHT OF STANDARD UNIT AND CHANGES DRAIN SIZE.
- 4) HANGER HOLES ARE FOR 3/4 INCH THREADED ROD.

PROJECT	ROOM	SHIPPING WEIGHT 2360 lbs	OPERATING WEIGHT 2670 lbs
---------	------	--------------------------	---------------------------