

CONFIDENTIAL
 This document is the property of Evapco, Inc. It should not be copied or disclosed without prior written authorization.

EVAPCO, INC.

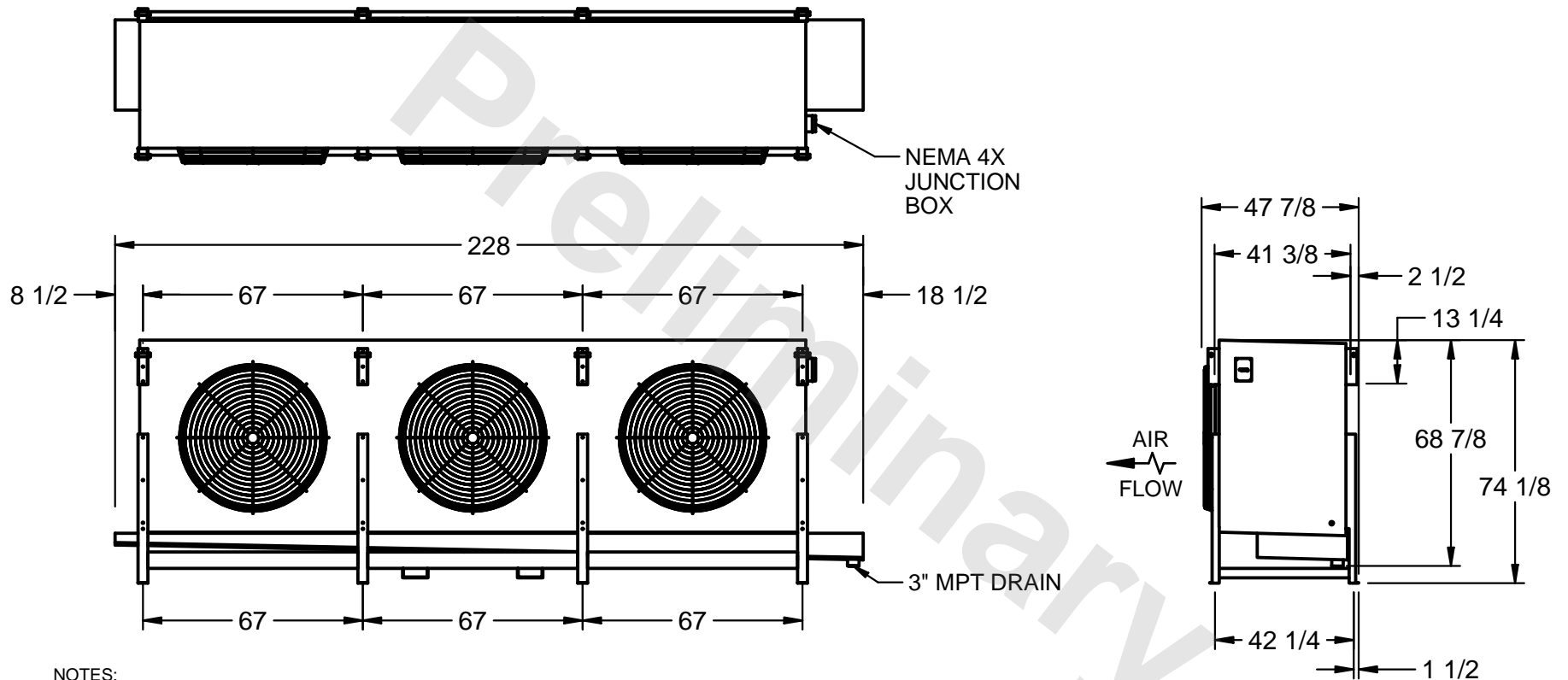

| | | | | | |
|----------|---------------------------------|-----------------|-------------------------|--------|------------------|
| CUSTOMER | MODEL # SSTHB3-758VF0750K1MA | SCALE N.T.S. | DWG. # STL3-SE-18-FL | REV. 1 | DATE 5/4/2026 |
|----------|---------------------------------|-----------------|-------------------------|--------|------------------|



NOTES:

- 1) RIGHT HAND MODEL SHOWN.
- 2) ALL DIMENSIONS ARE FOR REFERENCE AND SHOULD NOT BE USED FOR PREFABRICATION OF PIPING OR SUPPORTS.
- 3) WATER DEFROST ADDS 6 INCHES TO HEIGHT OF STANDARD UNIT AND CHANGES DRAIN SIZE.
- 4) HANGER HOLES ARE FOR 3/4 INCH THREADED ROD.

| | | | |
|---------|------|--------------------------|---------------------------|
| PROJECT | ROOM | SHIPPING WEIGHT 3570 lbs | OPERATING WEIGHT 4120 lbs |
|---------|------|--------------------------|---------------------------|