

- NOTES:
1. (M)- FAN MOTOR LOCATION
  2. HEAVIEST SECTION IS COIL SECTION
  3. MPT DENOTES MALE PIPE THREAD  
 FPT DENOTES FEMALE PIPE THREAD  
 BFW DENOTES BEVELED FOR WELDING  
 GVD DENOTES GROOVED  
 FLG DENOTES FLANGE
  4. +UNIT WEIGHT DOES NOT INCLUDE ACCESSORIES (SEE ACCESSORY DRAWINGS)
  5. 3/4" [19MM] DIA. MOUNTING HOLES. REFER TO RECOMMENDED STEEL SUPPORT DRAWING
  6. MAKE-UP WATER PRESSURE  
 20 psi MIN [137 kPa], 50 psi MAX [344 kPa]
  7. DIMENSIONS LISTED AS FOLLOWS:  
 ENGLISH FT-IN  
 [METRIC] [mm]
  8. \* - APPROXIMATE DIMENSIONS DO NOT USE FOR PRE-FABRICATION OF CONNECTING PIPING

**FACE B  
 PLAN VIEW**

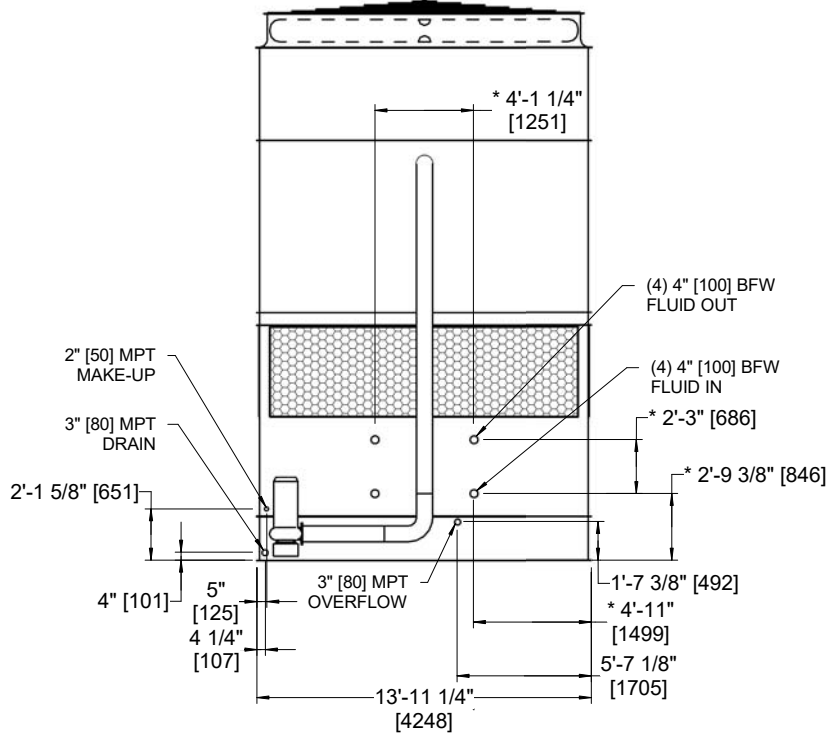

**FACE A**



**FACE B**

**FACE A**

MODEL NUMBER	DIMENSION A
ESW4 14-54*22-LP	2'-1 3/4"
ESW4 14-54*22-AP	2'-7 1/4"