

UNIT	CLOSED CIRCUIT COOLER	
MODEL #	ESW4 12-26K18X-SF	SCALE NTS

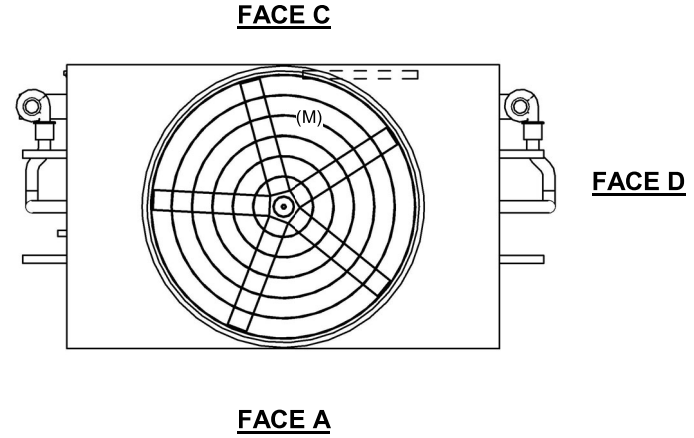

DWG. #	WX41218X2412F-DRA-ST	REV	-
SERIAL #		DATE:	6/27/2026

- NOTES:
- (M)- FAN MOTOR LOCATION
 - HEAVIEST SECTION IS COIL SECTION
 - MPT DENOTES MALE PIPE THREAD
FPT DENOTES FEMALE PIPE THREAD
BFW DENOTES BEVELED FOR WELDING
GVD DENOTES GROOVED
FLG DENOTES FLANGE
 - +UNIT WEIGHT DOES NOT INCLUDE ACCESSORIES (SEE ACCESSORY DRAWINGS)
 - 3/4" [19MM] DIA. MOUNTING HOLES. REFER TO RECOMMENDED STEEL SUPPORT DRAWING
 - MAKE-UP WATER PRESSURE
20 psi MIN [137 kPa], 50 psi MAX [344 kPa]
 - DIMENSIONS LISTED AS FOLLOWS:
ENGLISH FT-IN
[METRIC] [mm]
 - * - APPROXIMATE DIMENSIONS DO NOT USE FOR PRE-FABRICATION OF CONNECTING PIPING
 - COIL CONNECTIONS LOCATED ON FACES B AND D



**FACE B
PLAN VIEW**

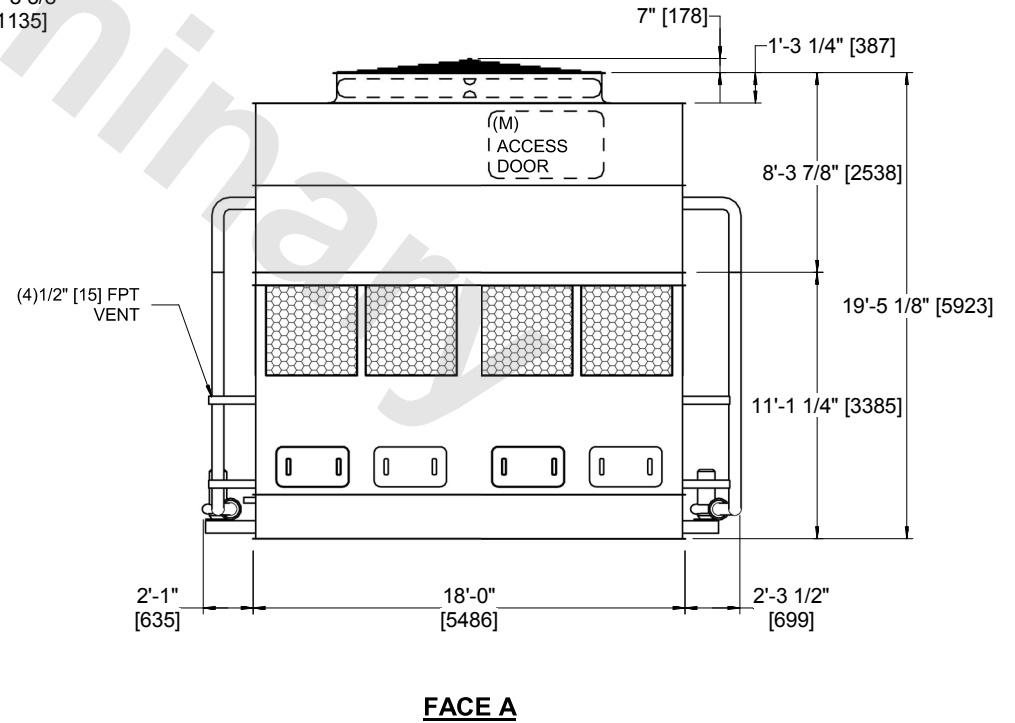
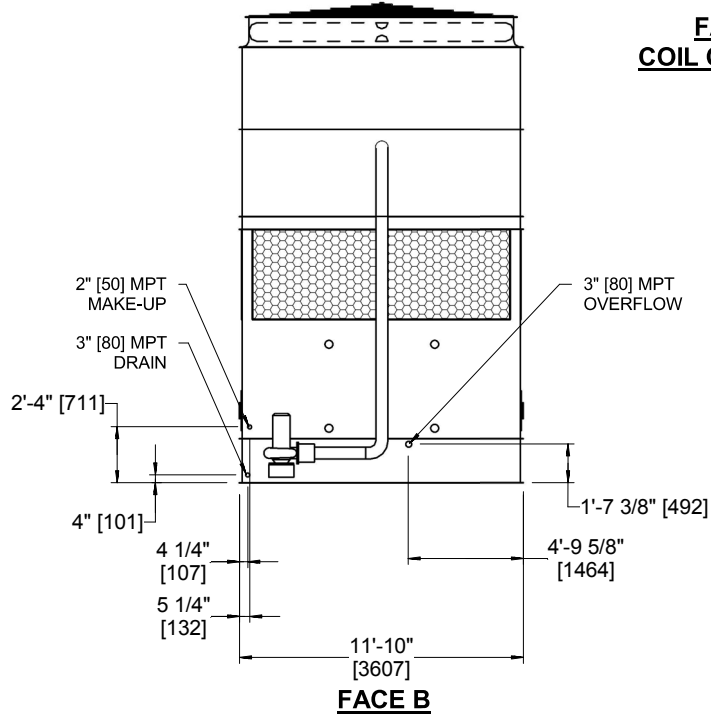

SHIPPING WEIGHT	35270 lbs+ [16000] kg+	OPERATING WEIGHT	51860 lbs+ [23525] kg+	HEAVIEST SECTION WEIGHT	28610 lbs+ [12980] kg+	NO. OF SHIPPING SECTIONS	2	DRAWN BY:	AWT
-----------------	------------------------	------------------	------------------------	-------------------------	------------------------	--------------------------	---	-----------	-----