

UNIT	CLOSED CIRCUIT COOLER
MODEL #	ESW4 12-44K18X-LF
SCALE	NTS

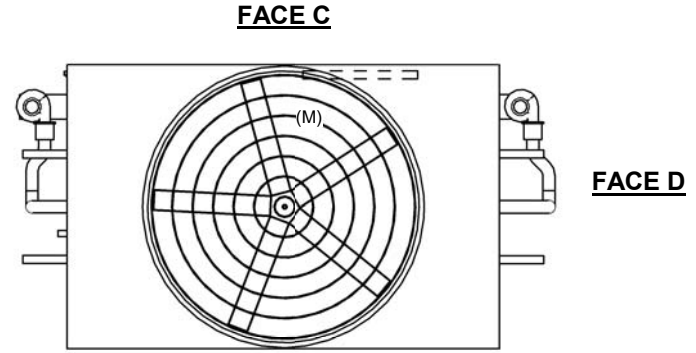

DWG. #	WX41218X4808F-DRA-ST	REV	-
SERIAL #		DATE:	7/6/2026

- NOTES:
- (M)- FAN MOTOR LOCATION
 - HEAVIEST SECTION IS COIL SECTION
 - MPT DENOTES MALE PIPE THREAD
FPT DENOTES FEMALE PIPE THREAD
BFW DENOTES BEVELED FOR WELDING
GVD DENOTES GROOVED
FLG DENOTES FLANGE
 - +UNIT WEIGHT DOES NOT INCLUDE ACCESSORIES (SEE ACCESSORY DRAWINGS)
 - 3/4" [19MM] DIA. MOUNTING HOLES. REFER TO RECOMMENDED STEEL SUPPORT DRAWING
 - MAKE-UP WATER PRESSURE
20 psi MIN [137 kPa], 50 psi MAX [344 kPa]
 - DIMENSIONS LISTED AS FOLLOWS:
ENGLISH FT-IN
[METRIC] [mm]
 - * - APPROXIMATE DIMENSIONS DO NOT USE FOR PRE-FABRICATION OF CONNECTING PIPING
 - COIL CONNECTIONS LOCATED ON FACES B AND D



**FACE B
PLAN VIEW**

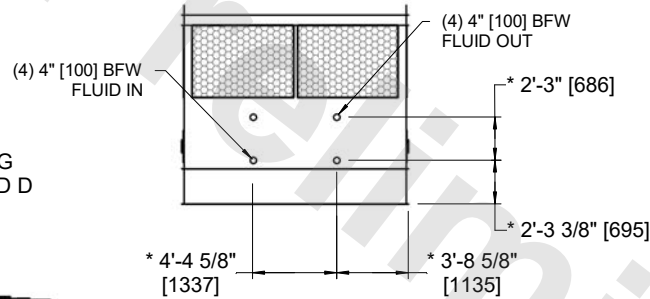

**FACE B & D
COIL CONNECTIONS**



FACE B

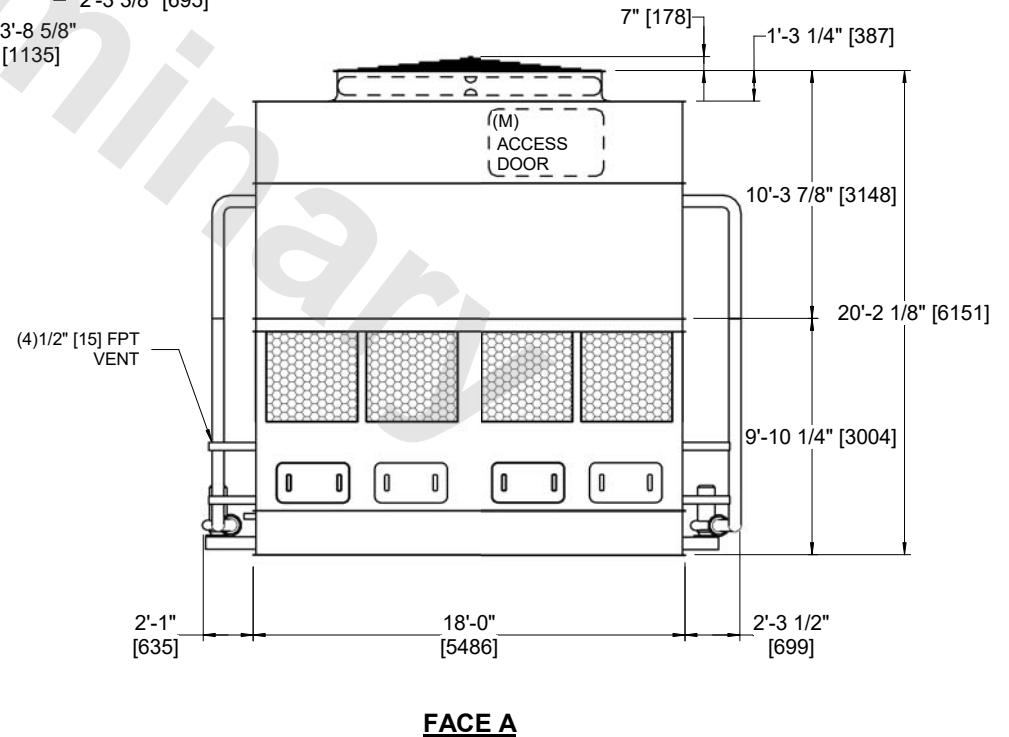

FACE A

SHIPPING WEIGHT	30130 lbs+ [13670] kg+	OPERATING WEIGHT	44330 lbs+ [20110] kg+	HEAVIEST SECTION WEIGHT	21980 lbs+ [9970] kg+	NO. OF SHIPPING SECTIONS	2	DRAWN BY:	AWT
-----------------	------------------------	------------------	------------------------	-------------------------	-----------------------	--------------------------	---	-----------	-----