

UNIT	CLOSED CIRCUIT COOLER
MODEL #	ESW4 9-25J18-LP
SCALE	NTS

EVAPCO, INC.

DWG. #	WX409182410P-DRA-ST	REV	-
SERIAL #		DATE:	5/7/2026

NOTES:

- (M)- FAN MOTOR LOCATION
- HEAVIEST SECTION IS COIL SECTION
- MPT DENOTES MALE PIPE THREAD
FPT DENOTES FEMALE PIPE THREAD
BFW DENOTES BEVELED FOR WELDING
GVD DENOTES GROOVED
FLG DENOTES FLANGE
- +UNIT WEIGHT DOES NOT INCLUDE ACCESSORIES (SEE ACCESSORY DRAWINGS)
- 3/4" [19MM] DIA. MOUNTING HOLES. REFER TO RECOMMENDED STEEL SUPPORT DRAWING
- MAKE-UP WATER PRESSURE
20 psi MIN [137 kPa], 50 psi MAX [344 kPa]
- DIMENSIONS LISTED AS FOLLOWS:
ENGLISH FT-IN
[METRIC] [mm]
- * - APPROXIMATE DIMENSIONS DO NOT USE FOR PRE-FABRICATION OF CONNECTING PIPING
- COIL CONNECTIONS LOCATED ON FACES B AND D



**FACE B
PLAN VIEW**

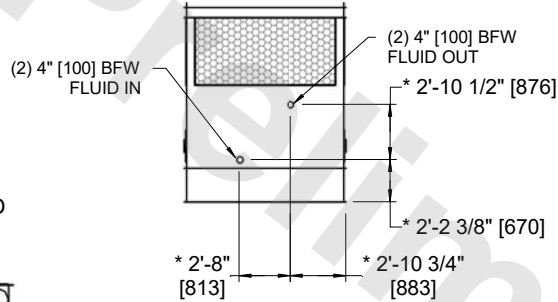

**FACE B & D
COIL CONNECTIONS**

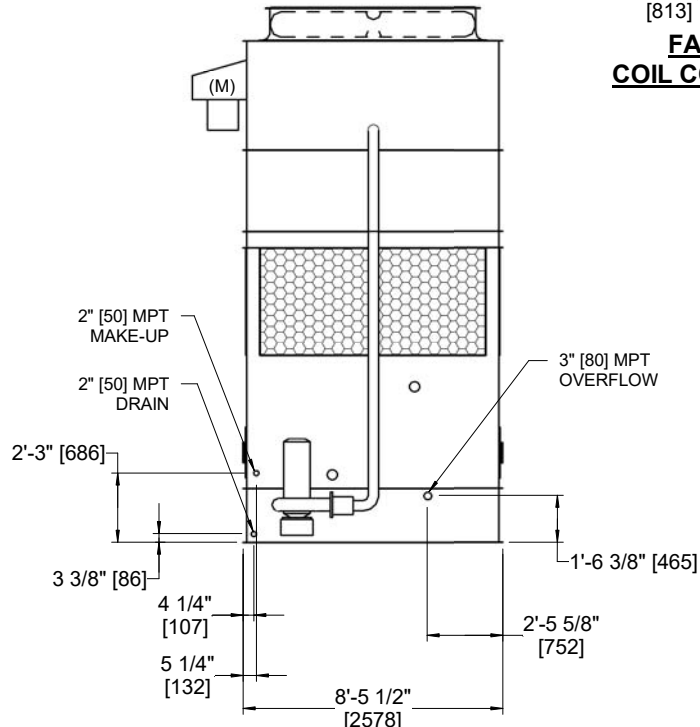

FACE B

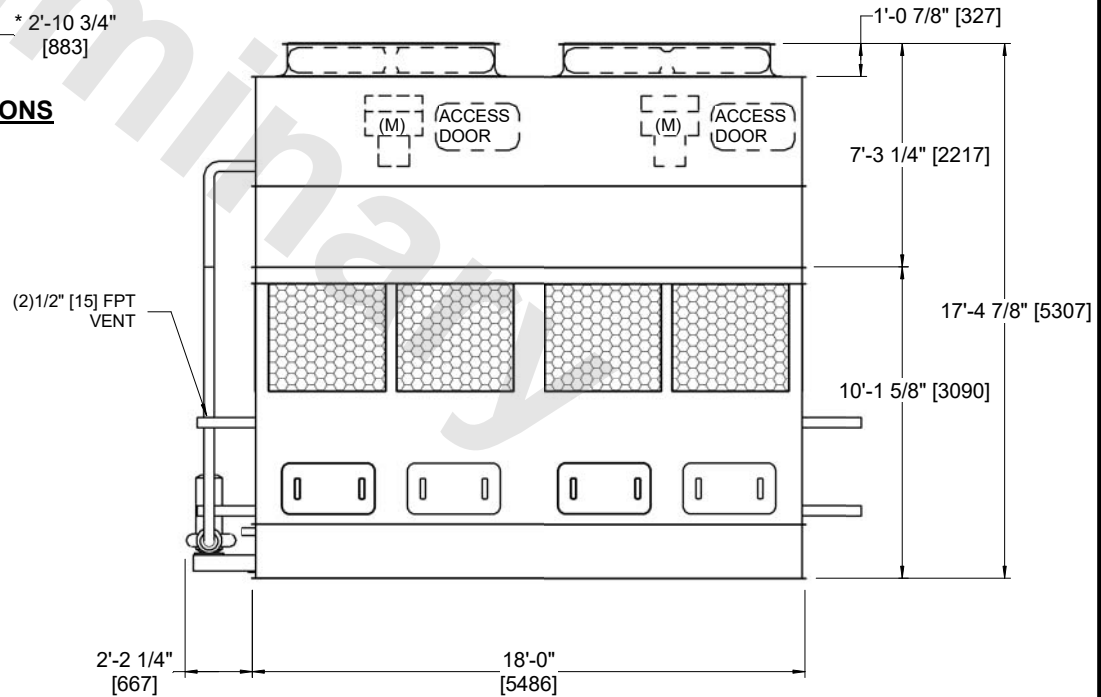

FACE A

SHIPPING WEIGHT	21660 lbs+ [9825] kg+	OPERATING WEIGHT	30900 lbs+ [14020] kg+	HEAVIEST SECTION WEIGHT	15420 lbs+ [6995] kg+	NO. OF SHIPPING SECTIONS	2	DRAWN BY:	AWT
-----------------	-----------------------	------------------	------------------------	-------------------------	-----------------------	--------------------------	---	-----------	-----