

|         |                       |
|---------|-----------------------|
| UNIT    | CLOSED CIRCUIT COOLER |
| MODEL # | ESW4 9-2316-LP        |
| SCALE   | NTS                   |

# EVAPCO, INC.



|          |                     |       |          |
|----------|---------------------|-------|----------|
| DWG. #   | WX409062406P-DRA-ST | REV   | -        |
| SERIAL # |                     | DATE: | 5/6/2026 |

- NOTES:
- (M)- FAN MOTOR LOCATION
  - HEAVIEST SECTION IS COIL SECTION
  - MPT DENOTES MALE PIPE THREAD  
FPT DENOTES FEMALE PIPE THREAD  
BFW DENOTES BEVELED FOR WELDING  
GVD DENOTES GROOVED  
FLG DENOTES FLANGE
  - +UNIT WEIGHT DOES NOT INCLUDE ACCESSORIES (SEE ACCESSORY DRAWINGS)
  - 3/4" [19MM] DIA. MOUNTING HOLES. REFER TO RECOMMENDED STEEL SUPPORT DRAWING
  - MAKE-UP WATER PRESSURE  
20 psi MIN [137 kPa], 50 psi MAX [344 kPa]
  - DIMENSIONS LISTED AS FOLLOWS:  
ENGLISH FT-IN  
[METRIC] [mm]
  - \* - APPROXIMATE DIMENSIONS DO NOT USE FOR PRE-FABRICATION OF CONNECTING PIPING

**FACE C**



**FACE B  
PLAN VIEW**

**FACE D**

**FACE A**

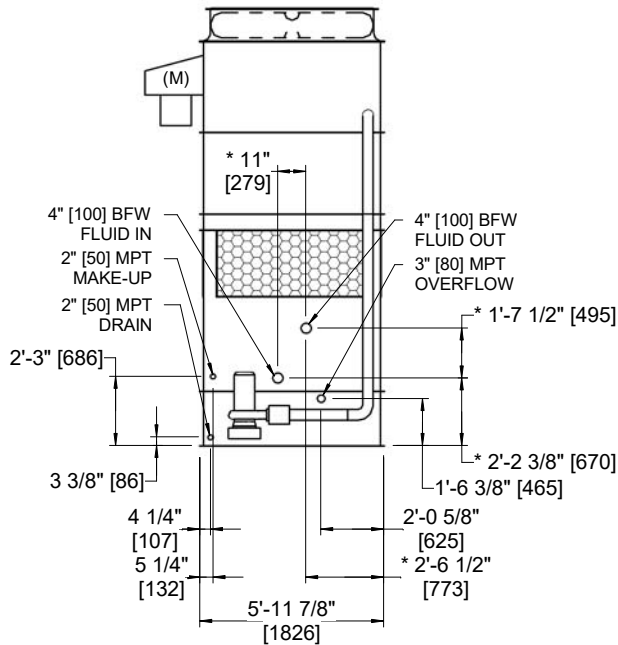

**FACE B**

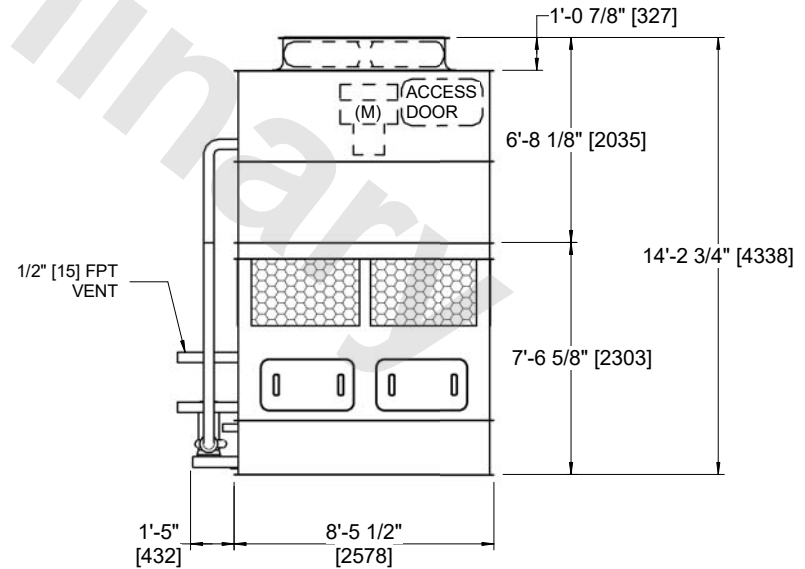

**FACE A**

|                 |                      |                  |                      |                         |                      |                          |   |           |     |
|-----------------|----------------------|------------------|----------------------|-------------------------|----------------------|--------------------------|---|-----------|-----|
| SHIPPING WEIGHT | 6820 lbs+ [3095] kg+ | OPERATING WEIGHT | 9700 lbs+ [4400] kg+ | HEAVIEST SECTION WEIGHT | 4760 lbs+ [2160] kg+ | NO. OF SHIPPING SECTIONS | 2 | DRAWN BY: | AWT |
|-----------------|----------------------|------------------|----------------------|-------------------------|----------------------|--------------------------|---|-----------|-----|