

| | | |
|---------|---------------|-----------|
| UNIT | COOLING TOWER | |
| MODEL # | AT 214-219 | SCALE NTS |

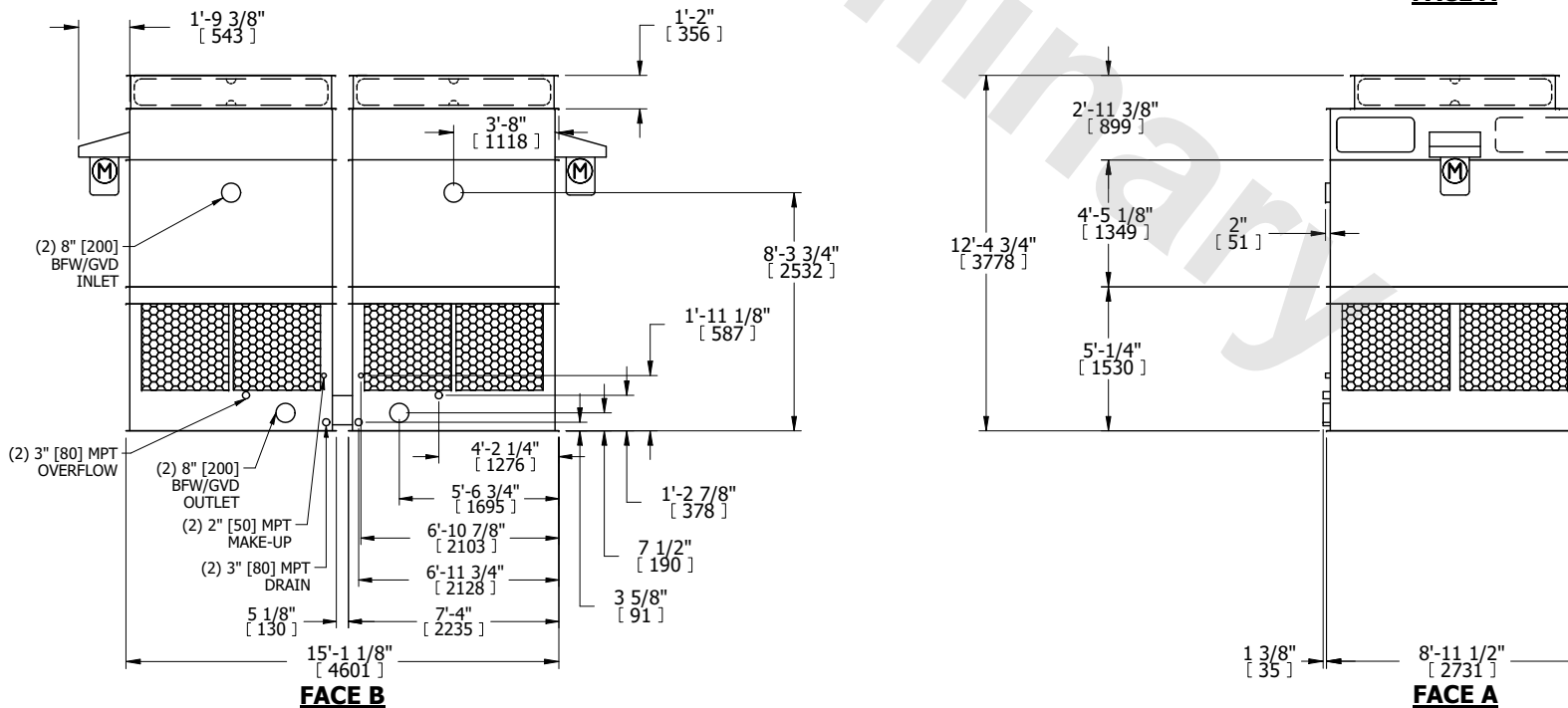

| | | | |
|----------|-------------------|------|----------|
| DWG. # | CT4C140924-DRA-ST | REV. | - |
| SERIAL # | | DATE | 5/9/2026 |

- NOTES:
- (M)- FAN MOTOR LOCATION
 - HEAVIEST SECTION IS FAN/CASING SECTION
 - MPT DENOTES MALE PIPE THREAD
FPT DENOTES FEMALE PIPE THREAD
BFW DENOTES BEVELED FOR WELDING
GVD DENOTES GROOVED
FLG DENOTES FLANGE
 - +UNIT WEIGHT DOES NOT INCLUDE ACCESSORIES (SEE ACCESSORY DRAWINGS)
 - 3/4" [19MM] DIA. MOUNTING HOLES. REFER TO RECOMMENDED STEEL SUPPORT DRAWING
 - DIMENSIONS LISTED AS FOLLOWS:
ENGLISH FT-IN
[METRIC] [mm]
 - MAKE-UP WATER PRESSURE
20 psi MIN [137 kPa], 50 psi MAX [344 kPa]



| | | | | | | | | | |
|-----------------|----------------------|------------------|-----------------------|-------------------------|----------------------|--------------------------|---|-----------|-----|
| SHIPPING WEIGHT | 8120 lbs+ [3685] kg+ | OPERATING WEIGHT | 11840 lbs+ [5375] kg+ | HEAVIEST SECTION WEIGHT | 2630 lbs+ [1195] kg+ | NO. OF SHIPPING SECTIONS | 4 | DRAWN BY: | MBG |
|-----------------|----------------------|------------------|-----------------------|-------------------------|----------------------|--------------------------|---|-----------|-----|